

Dear **International Fuel Ethanol Workshop & Expo 2018** Exhibitor:

Valley Expo & Displays is pleased to have been selected as the Official Service Contractor for the upcoming **International Fuel Ethanol Workshop & Expo 2018**, being held at, **Century Link Center Omaha, June 11 - 13, 2018**. Included in this service kit are forms for ordering various services and equipment for your event. Please read each form carefully and return to the address provided on the order form. Refer to the enclosed General Show Information pages for vital facts and information about this event. If you have any additional questions about Valley Expo & Displays services, please do not hesitate to call or email Valley at the information provided below.

For your convenience Valley Expo & Displays offers online ordering. You can order your Valley services, view show schedule, review previous and current account information, and print invoices.

**To place online orders you will be required to register with Valley Online:**

- If you received this Exhibitor Service Kit in the “Ordering Open” email, a direct link and your temporary password to online ordering were included within that email. Click on the link to be directed to our website and begin ordering. (<https://valleyexpodisplays.boomerecommerce.com>)
- If you did not receive an email, visit, [www.valleyexpodisplays.com](http://www.valleyexpodisplays.com). Click on “Register and get your Password Here” to request your online credentials. Fill out the required information and submit. Once your request is processed you will receive an email with your login information. It may take up to two hours to generate your credentials. If your request is made on a holiday or weekend your login will be generated the next business day. We appreciate your patience in advance.

Valley  
Online  
Ordering

- Order early and take advantage of the advance pricing to receive discounted rates.
- Ship early to avoid delays. Shipments arriving late at show site will incur an additional cost and delays may occur.
- All correspondence, including final invoices, will be sent to the contact listed on the Recap of Cost & Payment form.
- Valley Expo & Displays will not accept orders without payment in full.

Helpful  
Hints

Valley Expo & Displays does not take orders over the phone. All pre show orders must be entered online at (<https://valleyexpodisplays.boomerecommerce.com>), faxed to (815-873-1544), or emailed to ([events@valleyexpodisplays.com](mailto:events@valleyexpodisplays.com)) by **June 4, 2018**. After this date orders must be placed at the service desk at the show site during exhibitor move-in. Items ordered at show site are subject to availability.

Ordering  
Information

Thank you for your business and we look forward to seeing you at the show!

Please contact our *Exhibitor Services Department* at  
877.332.4292 or email: [events@valleyexpodisplays.com](mailto:events@valleyexpodisplays.com) with any  
questions you may have.





**International Fuel Ethanol Workshop & Expo 2018**  
**Century Link Center Omaha, June 11 - 13, 2018**

**GENERAL**

General Show Information Pages 1, 2

**SHOW SPECIAL**

Booth Package Order Form Page 3

**BBI INTERNATIONAL**

Exhibit Rules and Regulations Pages 4, 5

**PAYMENT - CREDIT CARD AUTHORIZATION**

ReCap of Cost & Payment (Credit Card Auth) Page 6

**THIRD PARTY/EXHIBITOR APPOINTED CONTRACTOR**

Third Party Billing Page 7

Exhibitor Appointed Contractor Page 8

**BOOTH FURNITURE AND CARPET**

Table & Chairs Order Form Page 9

Accessories Order Form Page 10

Booth Carpet Order Form Page 11

**SHIPPING**

Shipping Addresses & Receiving Dates Page 12

Advance Shipment Label Page 13

Direct Shipment Label Page 14

YRC Freight Trade Show Services Information Pages 15, 16

Advance Shipment Freight Handling Form Page 17

Direct Shipment Freight Handling Form Page 18

Freight Service Questionnaire-**Must Complete** Page 19

Outbound Shipping Information Page 20

Outbound Bill of Lading Instruction Page 21

**VEHICLE PLACEMENT**

Vehicle Placement Order Form Page 22

**PORTABLE MODULAR DISPLAY RENTAL**

Portable Modular Display Rental Order Form Page 23

Exhibit Options by Valley Expo & Displays Page 24 - 33

**LABOR**

Event Labor Exhibitor Supervised Order Form Page 34

Event Labor Valley Supervised Order Form Page 35

Forklift Service Order Form Page 36

Booth & Exhibit Porter Service Order Form Page 37

**SIGN & BANNER**

Sign & Banner Order Form Page 38

**FLORAL EXHIBITS**

Plant & Floral Order Form Page 39

**SPECIALTY FURNISHING**

Specialty Furnishing Catalog Pages 40 - 71

Specialty Catalog Order Forms Pages 72 - 76

**CENTURY LINK CENTER OMAHA**

Exhibitor Rules & Regulations Pages 77 - 80

Exhibitor Utilities / Technical Services Order Forms Pages 81 - 84





Register Here for Online Ordering...  
[www.valleyexpodisplays.com](http://www.valleyexpodisplays.com)  
 EMAIL: [EVENTS@VALLEYEXPODISPLAYS.COM](mailto:EVENTS@VALLEYEXPODISPLAYS.COM)  
 FAX: 815.873.1544

## GENERAL SHOW INFORMATION

# International Fuel Ethanol Workshop & Expo 2018

Century Link Center Omaha, June 11 - 13, 2018

ADVANCE PRICE DEADLINE:  
May 18, 2018

### Valley Customer Service

- 815.873.1500 Fax 815.873.1544 email: [events@valleyexpodisplays.com](mailto:events@valleyexpodisplays.com)
- Office Hours: Mon - Fri; 8:00AM - 4:30PM (Central Standard Time)
- No telephone orders accepted; please complete and submit your order by Fax, Email, or Online.

### Show Management

- Janice Sue German
- 701.738.4964
- [jgerman@bbiinternational.com](mailto:jgerman@bbiinternational.com)

### Booth Package

A standard 10' x 10' booth will include:

- Green/White/White/Green 8' Back Drape and Green 3' Side Drape
- (1) 7" x 44" Identification Sign

Your exhibit area is **NOT** carpeted with facility carpeting. Aisles are carpeted in pepper color carpet.

**\*\* all exhibit areas are required to have a floor covering\*\***

### Exhibitor Schedule

<b>Exhibitor Move-In:</b>	Sunday	June 10, 2018	8:00AM - 5:00PM
	Monday	June 11, 2018	8:00AM - 12:00PM
<b>Show Hours:</b>	Monday	June 11, 2018	5:00PM - 6:30PM
	Tuesday	June 12, 2018	11:00AM - 6:30PM
	Wednesday	June 13, 2018	7:30AM - 1:30PM
<b>Exhibitor Move Out:</b>	Wednesday	June 13, 2018	1:30PM - 6:30PM

- Drivers for all carriers must be checked in at the Valley Freight Desk for pick-up of freight by: **3:30PM on 6/13/2018.**

### Shipping Addresses

#### Advance to Warehouse

Receiving Dates:  
5/11/2018 thru 6/6/2018

TO: Exhibiting Company Name and Booth #  
 FOR: International Fuel Ethanol Workshop & Expo 2018  
 C/O Valley Expo & Displays  
 YRC Freight  
 4480 S. 90th Street  
 Omaha NE 68127

#### Direct to Show Site

Receiving Dates and Times:  
6/10/2018; 8:00AM - 5:00PM  
6/11/2018; 8:00AM - 12:00PM

TO: Exhibiting Company Name and Booth #  
 FOR: International Fuel Ethanol Workshop & Expo 2018  
 C/O Valley Expo & Displays  
 Century Link Center Omaha  
 455 North 10th Street  
 Omaha NE 68102





Register Here for Online Ordering...  
[www.valleyexpodisplays.com](http://www.valleyexpodisplays.com)  
 EMAIL: [EVENTS@VALLEYEXPDISPLAYS.COM](mailto:EVENTS@VALLEYEXPDISPLAYS.COM)  
 FAX: 815.873.1544

## GENERAL SHOW INFORMATION

# International Fuel Ethanol Workshop & Expo 2018

Century Link Center Omaha, June 11 - 13, 2018

ADVANCE PRICE DEADLINE:  
May 18, 2018

### Important Deadlines

- Take advantage of advance order discount pricing! Orders must be received with payment in full no later than the following dates. Orders received with payment in full after advance price deadline will be invoiced at "Floor" pricing.

**Advance Price Deadline** **May 18, 2018**

- Freight received before or after receiving dates will incur an additional surcharge.

**Advance Shipments receiving dates :** **May 11, 2018 thru June 6, 2018**

**Show Site Shipments receiving dates:** **June 10, 2018; 8:00AM - 5:00PM**  
**June 11, 2018; 8:00AM - 12:00PM**

### Payment Policies

- Orders received without full payment or credit card information will not be processed.
- A credit card on file is required when using Valley Expo & Displays services, any additional charges incurred for equipment and/or services will be billed to the card on file. All charges must be paid prior to close of show.
- For your convenience, we accept all major credit cards as well as cash, checks, ACH, wire transfers.

### Cancellations & Adjustments

- Orders cancelled prior to move-in will be charged 50% of the original price. Orders cancelled after move-in begins will be charged 100% of the original price.
- Exhibitor may make adjustments to their order online before the pre show order deadline date.
- No adjustments/refunds will be issued after 14 days from the last day of the event, NO EXCEPTIONS

### Tax Exemption

- If your company is exempt for payment of sales tax, Valley Expo & Displays requires an exemption certificate for the state in which the services are used. Valley cannot omit sales tax from your order without a copy of your certificate.

### Third Party Payment Billing Exhibitor Appointed Contractor

- All third party and EAC forms must be completely filled out and submitted to Valley Expo & Displays. The exhibiting company is ultimately responsible for the payment of all charges. If no arrangements are made for payment of invoice(s) by the third party prior to the last day of the show, charges will revert back to the exhibitor.
- Exhibitor must inform their EAC that they must send a copy of their General Liability Insurance Certificate no later than 30 days prior to the first day of exhibitor move in or they will not be permitted to service your exhibit.

### Miscellaneous

- Rental items not ordered, yet found in booth space, are invoiced at "Floor" pricing.
- All rental items are subject to applicable taxes
- All rental items remain the property of Valley Expo & Displays.
- All rental items are subject to availability
- You are able to place your order without your booth number(s). Booth number(s) may be assigned at a later date and your order will be updated accordingly



**VALLEY**  
**EXPO & DISPLAYS**  
 BETTER IDEAS. BETTER RESULTS.  
 valleyexpodisplays.com



Register Here for Online Ordering...  
 www.valleyexpodisplays.com  
 EMAIL: EVENTS@VALLEYEXPDISPLAYS.COM  
 FAX: 815.873.1544

**BOOTH  
 PACKAGE**

**International Fuel Ethanol Workshop & Expo 2018**  
**Century Link Center Omaha, June 11 - 13, 2018**

**Booth Package Deadline:**  
**May 4, 2018**

Your booth space does not include a furniture package. Valley Expo & Displays is offering a discounted furniture package to all exhibitors at the rate listed below. In order to receive the discounted rate, all exhibitors must complete this form and fax back to Valley by **May 4, 2018 (this date differs from the Advanced Price Deadline Date).**

Booth Package A	Quantity	Show Special	Total
(1) 8' x 30" Skirted Table (2) Side Chairs		\$ 223.60	\$

Booth Package B	Quantity	Show Special	Total
(1) 8' x 42" Skirted Table (2) Bar Stools		\$ 294.80	\$

Subtotal \$ \_\_\_\_\_  
 7% Sales Tax \$ \_\_\_\_\_  
 Total \$ \_\_\_\_\_

Skirted Table Color Selection: Blue Silver Black White

**ORDER WITH PAYMENT MUST BE RECEIVED BY MAY 4, 2018.**

Please provide the following information so we may credit your account properly.

Company Name \_\_\_\_\_ Booth # \_\_\_\_\_ Date \_\_\_\_\_  
 Billing Address \_\_\_\_\_ City & State \_\_\_\_\_ Zip \_\_\_\_\_  
 E-Mail Address \_\_\_\_\_ Name (please print) \_\_\_\_\_  
 Phone \_\_\_\_\_ Fax \_\_\_\_\_ Check No. (if paying by check) \_\_\_\_\_  
 \_\_\_ Visa \_\_\_ MC \_\_\_ Amex Card Number \_\_\_\_\_ Exp. Date \_\_\_/\_\_\_ CVC2 \_\_\_\_\_  
3 digit or 4 digit code  
 (SIGNATURE REQUIRED BELOW ON ANY CREDIT CARD CHARGES)  
 X \_\_\_\_\_  
 Cardholder Signature \_\_\_\_\_ Cardholder's Name (please print) \_\_\_\_\_

BOOTH NUMBER:

COMPANY NAME:





## Exhibitor Rules & Regulations

### Booth Construction

All booth displays must be constructed so as to appear “finished” on all sides that may be visible, including from all adjoining booths. For example, if the framework structure of a pop-up booth is visible from an adjoining booth, that framework will need to be covered so as to not detract from the appearance of the adjoining booth. All exhibit displays should be designed and erected in a manner that will withstand normal contact or vibration caused by neighboring exhibitors, hall laborers or installation/dismantling equipment such as forklifts.

### Line of Sight

All exhibitors are entitled to a reasonable line of sight which varies by booth size and location. Generally, nothing should be over four feet (4') tall in the three feet (3') closest to the aisle. Regardless of the number of standard booths utilized, (e.g. 10'x20', 10'x30', 10'x40' etc.) display materials should be arranged in such a manner so as to not obstruct sight lines of neighboring exhibitors. The maximum height of eight feet (8') is allowed only in the rear of the booth space, with a four foot (4') height restriction imposed on all materials in the three feet closest to the aisle.

### Standard Booth

A standard booth consist of an area 10'x 10'x8' high. All display material over four feet (4') high, must be set back three feet (3') from the main aisle.

### Endcap Booth

An endcap booth is a 10'x20'x10' high booth exposed to aisles on three sides. The back wall is restricted to four feet (4') high within the three feet (3') closest to each aisle permitting adequate line of sight for the adjoining booths. The rest of the back wall can be no higher than ten feet (10'). Any portion of the back wall that extends beyond the eight foot (8') curtain must be finished (no exposed framing or structure) and may not carry any ad copy on the back side.

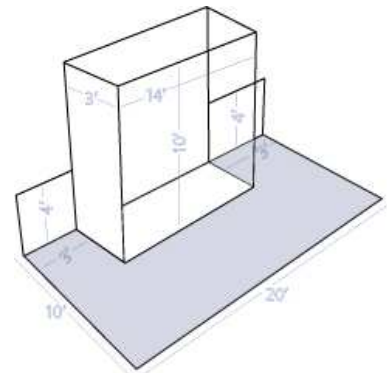

### Split Endcap Booth

A Split Endcap is a 10'x20'x10' high booth exposed to aisles on three sides and shares a common back wall with another Endcap booth. In both cases, the entire cubic content of the booth may be used. Any portion of the back wall that extends beyond the eight foot (8') curtain must be finished (no exposed framing or structure) and may not carry any ad copy.

### Peninsula Booth

Peninsula booths are any configuration of four or more booths exposed to aisles on three sides. Peninsula Booths are 20'x20'x16' high or larger. When a Peninsula booth backs up to two Standard Booths, the back wall is restricted to four feet (4') high within the three feet (3') closest to each aisle, in the back five feet (5') of the booth permitting adequate line of sight for the adjoining booths. The rest of the back wall can be no higher than sixteen feet (16'). Any portion of the back wall that extends beyond the eight foot (8') curtain must be finished (no exposed framing or structure) and may not carry any ad copy on the back side.



**Island Booth/Split Island Booth**

An Island booth is exposed to aisles on all four sides. A Split Island Booth is a Peninsula Booth which shares a common back wall with another Peninsula Booth. In both cases, the entire cubic content of the booth may be used up to sixteen feet (16'). Any portion of the back wall within five feet (5') of booth perimeter that extends beyond the eight foot (8') curtain must be finished (no exposed framing or structure) and may not carry any ad copy.

**Balloons**

Helium balloons may be used as booth decorations if securely fastened within the height restrictions of booth type, but balloon distribution is prohibited.

**Audio-Video/Music/Loud Demonstrations**

Expo management reserves the right to limit or restrict sounds from any source that interfere with activities in neighboring exhibits. In general, sounds should be no louder than 85 decibels. As a matter of safety and courtesy to others, exhibitors should conduct sales presentations and product demonstrations in a manner which assures all exhibitor personnel and attendees are within the contracted exhibit space and not encroaching on the aisle or neighboring exhibits. It is the responsibility of each exhibitor to arrange displays, product presentation and demonstration area to ensure compliance. Special caution should be taken when demonstrating machinery or equipment that has moving parts or any product that is potentially dangerous. Exhibitors should establish a minimum setback of three feet (3') and/or install hazard barriers as necessary to prevent accidental injury to spectators. Demonstrations involving sound need to be limited in frequency and are at the discretion of show management. Generally, a neighbor across the aisle should not be able to hear your demonstration.

**Hanging Signs and Graphics**

Whether suspended from above or supported from below, they should comply with all ordinary use-of-space requirements. The highest point of any sign in any booth should not exceed the maximum allowable height for that type of booth. Hanging signs and graphics should be set back a minimum of five feet (5') from adjacent booths and aisles. Multi-sided signs, projection screens or logos may not face an adjacent booth. This will include back walls, side panels, headers and towers.

**Floor Coverings**

All exposed floor area contained within the booth must be covered with carpet or other appropriate floor coverings.

**Variance**

Height variance fee is \$100. Expo management, in its sole discretion, may make exceptions to the height restrictions for some exhibitors as it considers advisable. Any exhibitor requesting a variance must submit the request in writing along with written approval from the exhibitors affected by the variance. Please send requests to [jgerman@bbiinternational.com](mailto:jgerman@bbiinternational.com).



Register Here for Online Ordering...  
[www.valleyexpodisplays.com](http://www.valleyexpodisplays.com)  
 EMAIL: [EVENTS@VALLEYEXPDISPLAYS.COM](mailto:EVENTS@VALLEYEXPDISPLAYS.COM)  
 FAX: 815.873.1544

**RECAP OF COST & PAYMENT**

ADVANCE PRICE DEADLINE:  
 May 18, 2018

**International Fuel Ethanol Workshop & Expo 2018**  
**Century Link Center Omaha, June 11 - 13, 2018**

This form with your credit card information, and all applicable order forms must be forwarded to Valley Expo & Displays. Advance prices apply **only** to orders received with payment in full by the advance price deadline date. All orders received afterward, or at the show site will be subject to floor rates. **We cannot accept phone orders**, however, you may fax/mail/email your order to us, provided we have your complete, valid credit card information. You will receive an order confirmation once your order has been placed. All correspondence and final invoices will be emailed to the contact listed below.

For your convenience, when you pay with a credit card, any additional charges incurred for equipment and services will be billed to your card. In any event, no services will be rendered until payment in full has been received.

**Terms**

Exhibitors who have applied for special billing considerations, and to whom credit is extended agree to pay as a service charge 1 - 1/2% per month (18% per annum) and to pay all costs of collection, including a reasonable attorney's fee on all charges not paid within 30 days of invoice date. Payment for labor and services ordered by the exhibitor, their display house or other third parties is the responsibility of the exhibitor. The undersigned (jointly or severally) hereby does primarily and unconditionally guarantee the payment and discharge at maturity of each and every obligation incurred by this designate or assigns (display house or third party agent) in such transaction and agrees in the event of default by such third party of any such obligation to pay and otherwise make good on demand by Valley Expo & Displays or its assigns at any time thereafter, any sums and obligations then owing by the exhibitor to Valley Expo & Displays.

**SERVICES AND EQUIPMENT ORDERED**

- Booth Furniture Order Form
- Accessories Order Form
- Booth Carpet Order Form
- Freight Handling Order Form
- Vehicle Placement Order Form
- Portable/Modular Display Rental Order Form
- Event Labor Order Form
- Forklift Service Order Form
- Booth & Exhibit Porter Service Order Form
- Sign & Banner Order Form

**Total Now Due**

\$ \_\_\_\_\_  
 \$ \_\_\_\_\_  
 \$ \_\_\_\_\_  
 \$ \_\_\_\_\_  
 \$ \_\_\_\_\_  
 \$ \_\_\_\_\_  
 \$ \_\_\_\_\_  
 \$ \_\_\_\_\_  
 \$ \_\_\_\_\_  
 \$ \_\_\_\_\_  
 \$ \_\_\_\_\_  
 \$ \_\_\_\_\_  
 \$ \_\_\_\_\_

**Order Summary**

Please provide the following information so we may credit your account properly. All correspondents including final invoice(s) will be emailed to the contact provided below.

Company Name \_\_\_\_\_ Booth # \_\_\_\_\_ Date \_\_\_\_\_

Billing Address \_\_\_\_\_ City & State \_\_\_\_\_ Zip Code \_\_\_\_\_

Email Address \_\_\_\_\_ Name (please print) \_\_\_\_\_

Phone \_\_\_\_\_ Fax \_\_\_\_\_ Check No. (if paying by check) \_\_\_\_\_

\_\_\_\_ Visa \_\_\_\_ MC \_\_\_\_ AMEX \_\_\_\_ Discover \_\_\_\_\_ Exp. Date \_\_\_\_/\_\_\_\_/\_\_\_\_ CVCS \_\_\_\_\_

\_\_\_\_\_ Card Number \_\_\_\_\_

X \_\_\_\_\_ Cardholder Signature \_\_\_\_\_ Cardholder's Name (please print) \_\_\_\_\_





**VALLEY**  
BETTER IDEAS. BETTER RESULTS.  
valleyexpodisplays.com



Register Here for Online Ordering...  
[www.valleyexpodisplays.com](http://www.valleyexpodisplays.com)  
EMAIL: [EVENTS@VALLEYEXPDISPLAYS.COM](mailto:EVENTS@VALLEYEXPDISPLAYS.COM)  
FAX: 815.873.1544

**THIRD  
PARTY  
BILLING**

**International Fuel Ethanol Workshop & Expo 2018**  
**Century Link Center Omaha, June 11 - 13, 2018**

This form is to be used if you wish to have a Third Party handle your display, and be billed for services. The Recap of Cost & Payment Form **MUST** be completed by the Third Party to be billed for services, **however, we also must be provided with the Exhibiting Company's credit card information below for our files.** Unless otherwise requested, all charges incurred will be billed to the Third Party.

It should be understood that by signing this form or placing an order the Exhibiting Company agrees it is ultimately responsible for payment of charges. **If your Third Party does not pay all charges in full before the end of the show, all charges will revert to the exhibiting company, due on receipt.**

**Exhibiting Company Name:** \_\_\_\_\_ **Booth #:** \_\_\_\_\_

Exhibitor Name: \_\_\_\_\_

Exhibitor Signature: \_\_\_\_\_

**Exhibiting Company's credit card information:**

\_\_\_ Visa \_\_\_ MC \_\_\_ Amex \_\_\_ Discover \_\_\_/\_\_\_ Exp. Date \_\_\_ CVC2  
Last 3 digits on back of card, 4 digits on front of AMX

Account #: \_\_\_\_\_

X

Cardholder's Signature

Print Cardholder's Name

Cardholder's Billing Address

City

State

Zip

Exhibiting  
Company  
Information

Services  
to be  
billed to  
third party

Indicate which services are to be invoiced to the Third Party:

\_\_\_ ALL VALLEY SERVICES  
\_\_\_ I&D LABOR/SUPERVISION  
\_\_\_ MATERIAL HANDLING IN & OUT

\_\_\_ RENTAL FURNITURE/CARPET/SIGNS  
\_\_\_ BOOTH CLEANING  
\_\_\_ OTHER: \_\_\_\_\_

**Third Party Company Name:** \_\_\_\_\_

Contact Name: \_\_\_\_\_

E-Mail for Invoice: \_\_\_\_\_

Address: \_\_\_\_\_

City: \_\_\_\_\_ State: \_\_\_\_\_ Zip Code: \_\_\_\_\_

**Third Party Company's credit card information:**

\_\_\_ Visa \_\_\_ MC \_\_\_ Amex \_\_\_ Discover \_\_\_/\_\_\_ Exp. Date \_\_\_ CVC2  
Last 3 digits on back of card, 4 digits on front of AMX

Account #: \_\_\_\_\_

X

Cardholder's Signature

Print Cardholder's Name

Cardholder's Billing Address

City

State

Zip

Third Party  
Company  
Information



**VALLEY**  
BETTER IDEAS. BETTER RESULTS.  
valleyexpodisplays.com



Register Here for Online Ordering...  
[www.valleyexpodisplays.com](http://www.valleyexpodisplays.com)  
EMAIL: [EVENTS@VALLEYEXPDISPLAYS.COM](mailto:EVENTS@VALLEYEXPDISPLAYS.COM)  
FAX: 815.873.1544

**EXHIBITOR  
APPOINTED  
CONTRACTOR**

## International Fuel Ethanol Workshop & Expo 2018

Century Link Center Omaha, June 11 - 13, 2018

Submit this form if the exhibiting company intends to use a contractor other than Valley Expo & Displays. If the exhibiting company fails to comply with any of the requirements listed below the exhibitor appointed contractor will not be permitted to service your exhibit, and Valley Expo & Displays must be hired for installation and dismantle labor. The exhibitor appointed contractor will be able to provide supervision only.

Exhibitor appointed contractors must use labor supplied by Valley Expo & Displays unless the following requirements are fulfilled:

1. The exhibitor must notify Show Management and Valley Expo & Displays of the intention to utilize an independent contractor no later than 30 days prior to the first day of move-in, furnishing the name, address and telephone number of the firm.
2. The Exhibitor shall provide evidence that the Exhibitor Appointed Contractor has proper certificates of insurance with at least the minimum as described below, unless Show Management requires more.
  - a. Comprehensive General Liability not less than \$1,000,000 with respect to injuries to any one person in an occurrence.
  - b. \$2,000,000 with respect to injuries to more than one person in any occurrence.
  - c. Workers' Compensation Insurance including employee liability coverage in the minimum amount not less than \$1,000,000 of individual and/or aggregate coverage and/or statutory limitation.
  - d. Automobile Liability with a limit of not less than \$1,000,000 combined single limit - each accident.
  - e. Umbrella/Excess Liability with a limit of not less than \$1,000,000 each occurrence and {\$1,000,000} each aggregate.
  - f. **Valley Expo & Displays, Show Management and Facility must be named as additional insureds on a primary and non-contributory basis.**
3. The exposition floor, aisles, loading docks, service and storage areas will be under the control of the Official Service Contractor, Valley Expo & Displays.
4. For services such as electrical, plumbing, telephone, and cleaning and drayage, no contractor other than the Official Service Contractor will be approved. This regulation is necessary due to licensing, insurance, and work done on equipment and facilities owned by parties other than the Exhibitor. Exhibitors shall provide only the material and equipment they own and is to be used in their exhibit space.
5. The Exhibitor Appointed Contractor:
  - a. Must agree to abide by all rules and regulations of the show, as outlined in this exhibitor kit, including all union rules and regulations.
  - b. Will share with Valley Expo & Displays all reasonable costs related to its operation, including but not limited to overtime pay for stewards, restoration of exhibit space to its initial condition.
  - c. Must furnish Show Management and Valley Expo & Displays with the names of all on-site employees who will be working on the exposition floor and see that they have and wear at all times necessary identification badges as determined by Show Management.
  - d. Shall be prepared to show evidence that it has a valid authorization from the Exhibitor for services.  
The exhibitor Appointed Contractor may not solicit business on the exhibit floor.
  - e. Must confine its operations to the exhibit area of its clients. No service desks, storage areas, or other work facilities will be located anywhere in the building. The show aisles and public space are not a part of the exhibitor's booth space and must be kept clear.
  - f. Shall provide, if requested, evidence to Valley Expo & Displays that it possesses applicable and current labor contracts and must comply with all labor agreements and practices. The Exhibitor Appointed Contractor must not commit or allow to be committed by persons in its employment any acts could lead to work stoppages, strikes, or labor problems.
  - g. Must coordinate all of its activities with Valley Expo & Displays.
  - h. Must comply with all reasonable rules and regulations of the venue, Show Management and Official Service Contractor in order to create a safe work environment. A failure to do so can result in a delay or termination of your right to continue if the condition cannot be corrected.
6. All information must be received by Valley Expo & Displays' office no later than 30 days prior to the first day of move-in.

**Contractor  
Requirements**

**Exhibiting Company Name:** \_\_\_\_\_

**Booth Number:** \_\_\_\_\_

**Exhibitor Appointed Contractor:** \_\_\_\_\_

**Address:** \_\_\_\_\_

**City:** \_\_\_\_\_ **State:** \_\_\_\_\_ **Zip Code:** \_\_\_\_\_

**Phone Number:** \_\_\_\_\_

**Email Address:** \_\_\_\_\_

**Contact at Show:** \_\_\_\_\_

**Type of Service to be performed:** \_\_\_\_\_

**Contractor  
Information**





Register Here for Online Ordering...  
 www.valleyexpodisplays.com  
 EMAIL: EVENTS@VALLEYEXPODISPLAYS.COM  
 FAX: 815.873.1544

**TABLES & CHAIRS  
 ORDER FORM**

**International Fuel Ethanol Workshop & Expo 2018**  
**Century Link Center Omaha, June 11 - 13, 2018**

ADVANCE PRICE DEADLINE:  
 May 18, 2018

**Orders with payment in full must be received by May 18, 2018, for Advance Prices.**

All orders subject to availability of equipment. Prices include delivery to booth, set up and removal.  
**Be sure to indicate skirting color . Orders received without color indicated will receive Foreman's choice.**

**Skirting Color Selection:**

- Black  
  Blue  
  Burgundy  
  Red  
  Teal  
  Grey  
 Purple  
  Silver  
  Gold  
  Green

	Description	Quantity	Advance	Floor	Total
<b>Skirted Tables</b>	4' L x 30" H	_____	\$ 131.75	\$ 171.30	_____
	6' L x 30" H	_____	\$ 156.45	\$ 203.40	_____
	8' L x 30" H	_____	\$ 175.75	\$ 228.50	_____
	4' L x 42" H	_____	\$ 138.25	\$ 179.75	_____
	6' L x 42" H	_____	\$ 168.10	\$ 218.55	_____
	8' L x 42" H	_____	\$ 200.45	\$ 260.60	_____
<b>4th Side Skirting &amp; Drape</b>	30" x 13' Skirting Only (4th Side)	_____	\$ 64.00	\$ 83.20	_____
	42" x 13' Skirting Only (4th Side)	_____	\$ 74.05	\$ 96.30	_____
	3' Drape (Side) per LnFt	_____	\$ 9.50	\$ 12.35	_____
	8' Drape (Back) per LnFt	_____	\$ 13.45	\$ 17.50	_____
<b>Plain Tables</b>	4' L x 30" H	_____	\$ 59.10	\$ 76.85	_____
	6' L x 30" H	_____	\$ 86.95	\$ 113.05	_____
	8' L x 30" H	_____	\$ 104.20	\$ 135.50	_____
	4' L x 42" H	_____	\$ 79.95	\$ 103.95	_____
	6' L x 42" H	_____	\$ 107.10	\$ 139.25	_____
	8' L x 42" H	_____	\$ 123.75	\$ 160.90	_____
	White Vinyl, 8' Long (tabletop covering)	_____	\$ 12.30	\$ 16.00	_____
<b>Cocktail Tables</b>	30" Round, 30" High	_____	\$ 99.85	\$ 129.85	_____
	30" Round, 42" High	_____	\$ 108.30	\$ 140.80	_____
<b>Chairs</b>	Side Chair	_____	\$ 51.90	\$ 67.50	_____
	Padded Chair	_____	\$ 66.75	\$ 86.80	_____
	Bar Stool with Back	_____	\$ 84.05	\$ 109.30	_____

<b>Subtotal</b>	\$	_____
<b>7% Sales Tax</b>	\$	_____
<b>Total</b>	\$	_____

*Must include Recap of Cost and Payment Form along with order form.*



Exhibiting Company Name: \_\_\_\_\_

Booth Number(s) \_\_\_\_\_



Register Here for Online Ordering...  
 www.valleyexpodisplays.com  
 EMAIL: EVENTS@VALLEYEXPDISPLAYS.COM  
 FAX: 815.873.1544

**ACCESSORIES  
ORDER FORM**

ADVANCE PRICE DEADLINE:  
May 18, 2018

**International Fuel Ethanol Workshop & Expo 2018**  
**Century Link Center Omaha, June 11 - 13, 2018**

**Orders with payment in full must be received by May 18, 2018, for Advance Prices.**

All orders subject to availability of equipment. Prices include delivery to booth and removal. All equipment remains property of Valley Expo & Displays. No orders will be accepted without payment in full.

Accessories

Description	Quantity	Advance	Floor	Total
Tripod Adjustable Easel	_____	\$ 34.05	\$ 44.30	_____
Garment Rack	_____	\$ 38.45	\$ 50.00	_____
Bag Stand	_____	\$ 83.15	\$ 108.10	_____
Literature Stand	_____	\$ 179.80	\$ 233.75	_____
Wastebasket	_____	\$ 15.45	\$ 20.10	_____
8' Upright with Base	_____	\$ 15.00	\$ 19.50	_____
Crossbar	_____	\$ 10.00	\$ 13.00	_____
Table Riser 1'x1'x4 White Skirted	_____	\$ 73.20	\$ 95.20	_____
Posterboard 4' x 8'	_____	\$ 227.10	\$ 295.25	_____
Horizontal / Vertical (Circle one)				

Labor to assemble Grid Wall is not included. Please refer to the Labor Order Form for assistance in assembling your grid wall if it will be needed.

Grid Wall

2' W x 4' H Panel	_____	\$ 37.50	\$ 48.75	_____
2' W x 6' H Panel	_____	\$ 43.45	\$ 56.50	_____
2' W x 8' H Panel	_____	\$ 55.10	\$ 71.65	_____
"T" Base, per set	_____	\$ 25.85	\$ 33.65	_____
24" Shelf Bracket	_____	\$ 14.20	\$ 18.50	_____
48" Shelf Bracket	_____	\$ 20.00	\$ 26.00	_____
6 Ball Waterfall	_____	\$ 9.45	\$ 12.30	_____
Hang Rail	_____	\$ 10.65	\$ 13.85	_____
Picture Hanger	_____	\$ 2.50	\$ 3.25	_____
Hat Display	_____	\$ 5.95	\$ 7.75	_____
Peg Hook	_____	\$ 2.50	\$ 3.25	_____
4", 6", 12" (circle one)				

Exhibiting Company Name: \_\_\_\_\_

Booth Number(s) \_\_\_\_\_

Subtotal	\$	_____
7% Sales Tax	\$	_____
<b>Total</b>	<b>\$</b>	<b>_____</b>

Must include Recap of Cost and Payment Form along with order form.





Register Here for Online Ordering...  
 www.valleyexpodisplays.com  
 EMAIL: EVENTS@VALLEYEXPDISPLAYS.COM  
 FAX: 815.873.1544

**BOOTH CARPET ORDER FORM**

**International Fuel Ethanol Workshop & Expo 2018**  
 Century Link Center Omaha, June 11 - 13, 2018

ADVANCE PRICE DEADLINE:  
 May 18, 2018

**Orders with payment in full must be received by May 18, 2018, for Advance Prices.**

All orders subject to availability of equipment. Prices include installation, front edge taping and pickup at the close of the show.  
**Carpet orders received without color indicated will receive Foreman's choice.**

**Color Selection for Crown Jewel 18 Carpeting**

- Blue
  Green
  Black
  Burgundy
  Red
  Gray

If carpet is ordered in multiples of two or more, the carpets are not guaranteed to be a color match and may not cover your entire booth area.

	Description	Quantity	Advance	Floor	Total
<b>Crown Jewel 18 Carpet</b>	10' x 10'	_____	\$ 211.30	\$ 274.70	_____
	10' x 20'	_____	\$ 423.35	\$ 550.40	_____
	10' x 30'	_____	\$ 634.50	\$ 824.85	_____

**Color Selection for Crown Jewel Custom Carpeting**

- Blue
  Green
  Black
  Burgundy
  Red
  Gray
  Green Jay
  Pepper

Custom size booth carpet is available in **10' widths only**. Include a layout for carpet installation if your carpet request is different from your booth size. If you require additional carpet to cover steps, skids, or display fixtures, please include a floorplan and a quote will be forwarded to you before we proceed

	Carpet Dimension	Square Foot	Advance	Floor	Total
<b>Crown Jewel Custom Booth Carpet</b>	_____ x _____	_____	\$ 4.60 sq ft	\$ 6.00 sq ft	_____

**Color Selection for Designer Plus Luxury Carpeting**

- Blue
  Green
  Black
  Burgundy
  Red
  Gray

Luxury carpet is cut specifically to your booth measurements. Rental also includes plastic covering (Visqueen) for your protection. Include a layout for carpet installation if your carpet request is different from your booth size. If you require additional carpet to cover steps, skids, or display fixtures, please include a floorplan and a quote will be forwarded to you before we proceed.

	Carpet Dimension	Square Foot	Advance	Floor	Total
<b>Designer Plus Luxury Booth Carpet</b>	_____ x _____	_____	\$ 4.90 sq ft	\$ 6.40 sq ft	_____

	Description	Square Foot	Advance	Floor	Total
<b>Padding Visqueen Taping</b>	Padding	_____	\$ 1.80 per sq ft	\$ 2.35 per sq ft	_____
	Visqueen (plastic covering)	_____	\$ 0.80 per sq ft	\$ 1.05 per sq ft	_____
	Additional taping	_____	\$ 1.80 per sq ft	\$ 2.35 per sq ft	_____

<b>Subtotal</b>	\$ _____
<b>7% Sales Tax</b>	\$ _____
<b>Total</b>	\$ _____

Must include Recap of Cost and Payment Form along with order form.



Exhibiting Company Name: \_\_\_\_\_

Booth Number(s) \_\_\_\_\_



**VALLEY**  
BETTER IDEAS. BETTER RESULTS.  
valleyexpodisplays.com



Register Here for Online Ordering...  
[www.valleyexpodisplays.com](http://www.valleyexpodisplays.com)  
EMAIL: [EVENTS@VALLEYEXPDISPLAYS.COM](mailto:EVENTS@VALLEYEXPDISPLAYS.COM)  
FAX: 815.873.1544

**SHIPPING  
ADDRESSES &  
RECEIVING DATES**

## International Fuel Ethanol Workshop & Expo 2018 Century Link Center Omaha, June 11 - 13, 2018

Exhibitors may choose to ship freight to the advance warehouse or directly to show site. Valley Expo & Displays will receive and manage the freight at the warehouse and/or on show site as described in the following pages. Freight handling fees are paid to Valley Expo & Displays for these freight handling services, and are separate from and independent of freight transportation charges, which are paid to a freight carrier such as YRC, ABF, FedEx or any other carrier of the exhibitor's choosing. Exhibitors are responsible for securing a carrier of their choosing and arranging freight transportation to and from the event, and all associated transportation fees.

All inbound shipments must have a Bill of Lading and/or certified weight ticket showing the number of pieces, type of merchandise and weight. Shipments received without this information will be delivered to exhibitor's booth without guarantee of piece count or condition. No liability will be assumed by Valley Expo & Displays for such shipments. The weight is rounded up the next one hundred pounds (100 lbs) and is taken from the inbound BOL and/or certified weight ticket. Separate shipments will not be combined. Shipments arriving without a specified weight on the BOL will be assigned an approximate weight by Valley. This weight will prevail.

### SHIPPING ADDRESS AND RECEIVING DATES

#### Advanced Warehouse Shipping Address

EXHIBITING COMPANY NAME  
BOOTH NUMBER  
**INTERNATIONAL FUEL ETHANOL  
WORKSHOP & EXPO 2018**  
YRC FREIGHT  
C/O VALLEY EXPO & DISPLAYS  
4480 S. 90TH STREET  
OMAHA NE 68127

- Use this address and information on your inbound bill of lading if shipping your freight to the advance warehouse
- For your convenience, please use the freight labels provided in this service kit.
- Receiving hours: M - F 7:30AM - 2:30PM
- All shipments must be prepaid: Collect shipments will be refused.

#### Advanced Warehouse Receiving Dates

First day freight will be accepted at advanced location: **5/11/2018**

Last day freight will be accepted: **6/6/2018**

#### Direct to Show Site Shipping Address

EXHIBITING COMPANY NAME  
BOOTH NUMBER  
**INTERNATIONAL FUEL ETHANOL  
WORKSHOP & EXPO 2018**  
CENTURY LINK CENTER OMAHA  
C/O VALLEY EXPO & DISPLAYS  
455 NORTH 10TH STREET  
OMAHA NE 68102

- Use this address and information on your inbound bill of lading if shipping your freight direct to the show site
- For your convenience, please use the freight labels provided in this service kit.
- All shipments must be prepaid: Collect shipments will be refused.

#### Direct to Show Site Receiving Dates and Times

**Do not send shipments to arrive in advance of 6/10/2018 to the show site.**  
**The facility has no means of storage, and will refuse your shipment.**

Days freight will be accepted at show site: **6/10/2018; \*8:00AM - 5:00PM**  
**6/11/2018; \*8:00AM - 12:00PM**

***\*Drivers must check in by One hour before end time***

**Authorization To Provide Freight Handling Services:** By completing the Freight Handling Order Form, it is understood that Valley Expo & Displays and its subcontractors do not automatically insure materials, that insurance, if any, shall be arranged by the Exhibitor and the amounts payable to Valley Expo & Displays for drayage services are based on the value of the material handling services and the scope of Valley Expo & Displays liability as herein set forth. The amounts payable to Valley Expo & Displays are unrelated to the value of the Exhibitor's property being handled by Valley Expo & Displays or its subcontractor. It is impractical and extremely difficult to fix the value of each shipment handled by Valley Expo & Displays or its subcontractors. It is agreed therefore that if Valley Expo & Displays or its subcontractors should be found liable for loss or damage to Exhibitor's materials, the liability shall be limited to the specific article that was physically lost or damaged. Such liability shall be limited to a sum equal to 30 cents per pound per article, with a maximum liability of \$500 per item, or \$1,000 per shipment, whichever amount shall be less, as agreed upon damages bit as a penalty, and such agreed upon damages shall be the Exhibitors exclusive remedy. Exhibits left on exhibit floor without return instructions will be returned to our warehouse and held for disposition at an additional charge. Valley Expo & Displays will not be responsible for condition, count or content until such time as exhibits or materials are picked up for removal after the close of the exhibition.

Register Here for Online Ordering... [www.valleyexpodisplays.com](http://www.valleyexpodisplays.com)



4950 AMERICAN ROAD · ROCKFORD, IL 61109 · PHONE: 815.873.1500 · FAX: 815.873.1544



<h1>RUSH</h1>
EXHIBITOR MATERIAL

FROM:

**ADVANCE SHIPMENT**

TO:

\_\_\_\_\_  
EXHIBITING COMPANY

INTERNATIONAL FUEL ETHANOL WORKSHOP & EXPO

\_\_\_\_\_  
SHOW NAME

\_\_\_\_\_  
BOOTH NUMBER

C/O VALLEY EXPO & DISPLAYS  
YRC FREIGHT  
4480 S. 90TH STREET  
OMAHA NE 68127

**Shipment Should Arrive Between:**  
May 11, 2018 thru June 6, 2018

CERTIFIED WEIGHT TICKETS ARE REQUIRED FOR ALL SHIPMENTS. Drivers must check in by 2:30 pm to be guaranteed same day unloading.

Carrier \_\_\_\_\_  
Number of pieces \_\_\_\_\_

<h1>RUSH</h1>
EXHIBITOR MATERIAL

FROM:

**ADVANCE SHIPMENT**

TO:

\_\_\_\_\_  
EXHIBITING COMPANY

INTERNATIONAL FUEL ETHANOL WORKSHOP & EXPO

\_\_\_\_\_  
SHOW NAME

\_\_\_\_\_  
BOOTH NUMBER

C/O VALLEY EXPO & DISPLAYS  
YRC FREIGHT  
4480 S. 90TH STREET  
OMAHA NE 68127

**Shipment Should Arrive Between:**  
May 11, 2018 thru June 6, 2018

CERTIFIED WEIGHT TICKETS ARE REQUIRED FOR ALL SHIPMENTS. Drivers must check in by 2:30 pm to be guaranteed same day unloading.

Carrier \_\_\_\_\_  
Number of pieces \_\_\_\_\_

# RUSH

EXHIBITOR MATERIAL

FROM:

## DIRECT SHIPMENT

TO:

EXHIBITING COMPANY

INTERNATIONAL FUEL ETHANOL WORKSHOP & EXPO

SHOW NAME

BOOTH NUMBER

C/O VALLEY EXPO & DISPLAYS  
CENTURY LINK CENTER OMAHA  
455 NORTH 10TH STREET  
OMAHA NE 68102

**Shipment Should Arrive:**

June 10, 2018; 8:00AM - 5:00PM  
June 11, 2018; 8:00AM - 12:00PM

CERTIFIED WEIGHT TICKETS ARE REQUIRED FOR ALL SHIPMENTS.

Carrier \_\_\_\_\_

Number of pieces \_\_\_\_\_

# RUSH

EXHIBITOR MATERIAL

FROM:

## DIRECT SHIPMENT

TO:

EXHIBITING COMPANY

INTERNATIONAL FUEL ETHANOL WORKSHOP & EXPO

SHOW NAME

BOOTH NUMBER

C/O VALLEY EXPO & DISPLAYS  
CENTURY LINK CENTER OMAHA  
455 NORTH 10TH STREET  
OMAHA NE 68102

**Shipment Should Arrive:**

June 10, 2018; 8:00AM - 5:00PM  
June 11, 2018; 8:00AM - 12:00PM

CERTIFIED WEIGHT TICKETS ARE REQUIRED FOR ALL SHIPMENTS

Carrier \_\_\_\_\_

Number of pieces \_\_\_\_\_





# Exhibit Services

Reliable trade show shipping services







### The show must go on!

YRC Freight is ready to customize transportation solutions for any exhibit shipment, any size load, delivering great service, savings and simplicity.

After the show, specify YRC Freight for the move out on the materials handling agreement (MHA), then give us a call. We'll take it from there.

And if others handle your trade show shipping, remember to tell them about YRC Freight savings and service.

## Delivering confidence at the show

- 100% inbound service guarantee\* at no additional cost
- On-site Exhibit managers monitor your inbound shipments for on-time, smooth move ins
- Time-Critical expedited
- Comprehensive North American coverage and online visibility

## Giving you more for your money

- Lowest trade show shipping fees in the industry
- 30 days free storage prior to the show; a great way to save when moving from show to show
- No detention fees at trade shows
- No extra fees for weekend/after-hour pickups

## Keeping it simple for you

- Exhibit customer service representatives available 24/7; call 1-800-531-EXPO (3976)
- Around-the-clock assistance with quotes, bookings, tracking or expediting
- Single-shipment transportation for your entire display
- Online shipment visibility throughout the move on [my.yrcfreight.com](http://my.yrcfreight.com)

\* Subject to applicable Tariffs and Rules and Conditions publications.

**Confidence Delivered:**

[yrcfreight.com](http://yrcfreight.com) | 800.531.EXPO (3976) |  Live Chat





Register Here for Online Ordering...  
 www.valleyexpodisplays.com  
 EMAIL: EVENTS@VALLEYEXPDISPLAYS.COM  
 FAX: 815.873.1544

**ADVANCE SHIPMENT  
 FREIGHT HANDLING  
 ORDER FORM**

**International Fuel Ethanol Workshop & Expo 2018  
 Century Link Center Omaha, June 11 - 13, 2018**

As the official service contractor, Valley Expo & Displays is the exclusive provider of freight services. Material handling includes unloading your exhibit material, storing up to 30 days in advance at the warehouse address, delivering it to the booth, handling of empty containers to and from storage, and removing of material from the booth for loading onto your outbound carrier. Shipments by carriers not giving delivery receipts or bill of lading, will be accepted and delivered to your booth space with no guarantee of piece count or condition. No liability whatsoever will attach to Valley Expo & Displays for those shipments. Valley Expo & Displays assumes no liability for lost or damaged items stored during any event. Cost to transport your exhibit material to and from the convention or event is not included.

**Information**

- Freight is accepted **5/11/2018** thru **6/6/2018**.
- To ensure timely arrival of your materials at show site, freight should arrive by **6/6/2018**. Freight will still be received after the deadline date; however, delays may occur and additional charges will apply.
- The warehouse receives shipments Monday through Friday, except holidays.
- The warehouse will accept crates, cartons, skids, trunks/cases and carpets.
- All shipments must have a bill of lading or delivery slip indicating the number of pieces, type of merchandise and weight.
- Certified weight tickets must accompany all shipments.
- Freight Questionnaire must be submitted with this form

**Advantages**

There are several advantages to shipping in advance to the warehouse versus directly to the show site:

- Exhibitors can confirm shipment has arrived in advance of the move-in date.
- Materials will be delivered to your booth prior to your arrival on site.
- Delivery dates and times are more flexible.

**Estimating Material Handling Charges**

- Charges will be based on the weight of your shipment. Each shipment received is considered separately. The shipment weight will be rounded to the next 100 lbs. Each 100 lbs. is considered one "cwt" (one hundred weight). All shipments are subject to reweigh. (200lbs minimum charged on all shipments weighing 51lbs - 200lbs)
- Select the category that best describes your shipment. There are two categories of freight:
  - Crated:** Material that is skidded or is in any type of shipping container that can be unloaded at the dock with no additional handling required.
  - Special Handling:** Material delivered by a carrier in such a manner that it requires additional handling, such as ground unloading, stacked or constricted space unloading, designated piece unloading, shipment integrity, alternate delivery location, loads mixed with pad wrapped material, carpet and/or pad only shipments, no documentation and shipments that require additional time, equipment or labor to unload. **Federal Express, UPS Ground, & DHL** are included in this category due to their delivery procedures.
- Add Overtime and/or Double Time surcharges for inbound if material is delivered to the booth during the overtime and/or double time period.
- Add Overtime and/or Double Time surcharges for outbound if material is loaded onto the outbound carrier during the overtime and/or double time period.
- Add the early/late surcharge if the shipment is accepted at the advance warehouse before or after the deadline dates listed above.

**Straight Time :** 8:00 AM to 4:30 PM Monday through Friday  
**Overtime:** 4:30 PM to 8:00 AM Monday through Friday; All day Saturday  
**Double Time:** All day Sunday and Holidays  
 (Overtime/Double Time will be applied to all freight received at the warehouse that must be moved into or out of booth during above listed times)

Rates	Rate Classifications	Price Per CWT	200lb Minimum
	Crated or Skidded	\$ 115.95	\$ 231.90
	Special Handling	\$ 150.60	\$ 301.20

**Small Package**

A small package shipment is a shipment totaling any number of pieces with a combined weight not to exceed 50lbs that is received on the same day from the same shipper and delivered by the same carrier

First Carton	\$ 68.55
Each Additional Carton	\$ 16.95

**Additional Surcharges**

Early/Late Delivery	20% Surcharge per CWT
Overtime - Inbound and/or Outbound	25% Surcharge per CWT
Double Time - Inbound and/or Outbound	50% Surcharge per CWT

**Estimate of Charges**

Rate Classification	Weight	CWT	Price Per CWT	Estimated
		÷ 100 =	\$	\$
<b>Additional Surcharges (% added to price per CWT)</b>				
Inbound	Out Bound		N/A	
_____ OT (+ 25%) _____ DT (+ 50%)	_____ OT (+ 25%) _____ DT (+ 50%)			
<b>Small Package</b>				
First Carton				\$
Additional Carton	_____ # of additional carton x \$16.95			\$
<b>Total Estimated</b>				\$

This calculation is only an estimate. Invoicing will be done from the actual weight. Adjustments will be made accordingly.

**VALLEY**  
BETTER IDEAS. BETTER RESULTS.  
valleyexpodisplays.com



Register Here for Online Ordering...  
[www.valleyexpodisplays.com](http://www.valleyexpodisplays.com)  
EMAIL: [EVENTS@VALLEYEXPDISPLAYS.COM](mailto:EVENTS@VALLEYEXPDISPLAYS.COM)  
FAX: 815.873.1544

**DIRECT SHIPMENT  
FREIGHT HANDLING  
ORDER FORM**

## International Fuel Ethanol Workshop & Expo 2018

### Century Link Center Omaha, June 11 - 13, 2018

As the official service contractor, Valley Expo & Displays is the exclusive provider of freight services. Material handling includes unloading your exhibit material, delivering it to the booth, handling of empty containers to and from storage, and removing of material from the booth for loading onto your outbound carrier. Shipments by carriers not giving delivery receipts or bill of lading, will be accepted and delivered to your booth space with no guarantee of piece count or condition. No liability whatsoever will attach to Valley Expo & Displays for those shipments. Valley Expo & Displays assumes no liability for lost or damaged items stored during any event. Cost to transport your exhibit material to and from the convention or event is not included.

#### Information

- Freight will be accepted: **6/10/2018; 8:00AM - 5:00PM & 6/11/2018; 8:00AM - 12:00PM**
- Do not ship to the facility prior to **6/10/2018**. Early shipments to the show site may be refused
- All shipments must have a bill of lading or delivery slip indicating the number of pieces, type of merchandise and weight
- Certified weight tickets must accompany all shipments
- Ship pre-paid; collect shipments will be refused
- Freight Questionnaire must be submitted with this form

#### Estimating Material Handling Charges

- Charges will be based on the weight of your shipment. Each shipment received is considered separately. The shipment weight will be rounded to the next 100 lbs. Each 100 lbs. is considered one "cwt" (one hundred weight). All shipments are subject to reweigh. (200lbs minimum charged on all shipments weighing 51lbs - 200lbs)
- Select the category that best describes your shipment. There are two categories of freight:
  - Crated:** Material that is skidded or is in any type of shipping container that can be unloaded at the dock with no additional handling required.
  - Special Handling:** Material delivered by a carrier in such a manner that it requires additional handling, such as ground unloading, stacked or constricted space unloading, designated piece unloading, shipment integrity, alternate delivery location, loads mixed with pad wrapped material, carpet and/or pad only shipments, no documentation and shipments that require additional time, equipment or labor to unload. **Federal Express, UPS Ground, & DHL** are included in this category due to their delivery procedures.
  - Uncrated:** material that is shipped loose or pad-wrapped, and/or unskidded machinery without proper lifting bars or hooks.
- Add overtime and/or double time charges for inbound if material is delivered to the booth during the overtime and/or double time period.
- Add overtime and/or double time charges for outbound if material is loaded onto the outbound carrier during the overtime and/or double time period.
- Add the early/late surcharge if the shipment is accepted at the show site before or after the deadline dates listed above.

**Straight Time :** 8:00 AM to 4:30 PM Monday through Friday  
**Overtime:** 4:30 PM to 8:00 AM Monday through Friday; All day Saturday  
**Double Time:** All day Sunday and Holidays  
(Overtime/Double Time will be applied to all freight received at the show site that must be moved into or out of booth during above listed times)

Rates	Rate Classifications	Price Per CWT	200lb Minimum
	Crated or Skidded	\$ 123.10	\$ 246.20
	Special Handling	\$ 159.85	\$ 319.70
	Uncrated	\$ 177.90	\$ 355.80

#### Small Package

A small package shipment is a shipment totaling any number of pieces with a combined weight not to exceed 50lbs that is received on the same day from the same shipper and delivered by the same carrier

First Carton	\$ 68.55
Each Additional Carton	\$ 16.95

#### Additional Surcharges

Early/Late Delivery	20% Surcharge per CWT
Overtime - Inbound and/or Outbound	25% Surcharge per CWT
Double Time - Inbound and/or Outbound	50% Surcharge per CWT

#### Estimate of Charges

Rate Classification	Weight	CWT	Price Per CWT	Estimated
	÷ 100 =		\$	\$
<b>Additional Surcharges (% added to price per CWT)</b>				
Inbound	Out Bound		N/A	
_____ OT (+ 25%) _____ DT (+ 50%)	_____ OT (+ 25%) _____ DT (+ 50%)			
<b>Small Package</b>				
First Carton				\$
Additional Carton	_____ # of additional carton x \$16.95			\$
<b>Total Estimated</b>				\$

This calculation is only an estimate. Invoicing will be done from the actual weight. Adjustments will be made accordingly.





Register Here for Online Ordering...  
www.valleyexpodisplays.com  
EMAIL: EVENTS@VALLEYEXPDISPLAYS.COM  
FAX: 815.873.1544

**FREIGHT SERVICE QUESTIONNAIRE**

**International Fuel Ethanol Workshop & Expo 2018**  
**Century Link Center Omaha, June 11 - 13, 2018**

**ALL EXHIBITORS SHIPPING FREIGHT  
MUST RETURN THIS FORM**

1. Estimate total number of pieces being shipped:

- \_\_\_\_\_ Crated
- \_\_\_\_\_ Uncrated
- \_\_\_\_\_ Machinery
- \_\_\_\_\_ Total

2. Indicate total number of trucks in each category that you will use:

- \_\_\_\_\_ Van Line
- \_\_\_\_\_ Common Carrier
- \_\_\_\_\_ Flatbed
- \_\_\_\_\_ Company Truck
- \_\_\_\_\_ Overseas Container

3. List carrier name(s):

\_\_\_\_\_

\_\_\_\_\_

\_\_\_\_\_

4. If using a Customs Broker, please print name:

\_\_\_\_\_

Phone \_\_\_\_\_

5. Print the name of person in charge of your move-in:

\_\_\_\_\_

Phone \_\_\_\_\_

6. What is the minimum number of days required to set your displays?

\_\_\_\_\_

7. What is the weight of the single heaviest piece that must be lifted?

\_\_\_\_\_ Lbs.

8. What is the total weight of your exhibit or equipment being shipped?

\_\_\_\_\_ Lbs.

9. Is there any special handling equipment required to unload your exhibit materials, i.e. extended forklift blades, special slings, lifting bars, etc.?

\_\_\_\_\_

\_\_\_\_\_

\_\_\_\_\_

It is the responsibility of the Exhibitor to provide proper special handling instructions. Failure to provide these instructions will result in the elimination of any liability for loss or damage by Valley Expo & Displays.

**DIRECT SHIPMENTS ONLY:**

1. What date and time are you scheduling your shipment(s) to arrive on-site?

\_\_\_\_\_

\_\_\_\_\_

Exhibiting Company Name: \_\_\_\_\_

Booth Number(s) \_\_\_\_\_





Register Here for Online Ordering...  
[www.valleyexpodisplays.com](http://www.valleyexpodisplays.com)  
 EMAIL: [EVENTS@VALLEYEXPDISPLAYS.COM](mailto:EVENTS@VALLEYEXPDISPLAYS.COM)  
 FAX: 815.873.1544

## OUTBOUND SHIPPING INFORMATION

### International Fuel Ethanol Workshop & Expo 2018 Century Link Center Omaha, June 11 - 13, 2018

Outbound shipping is not an automatic process. Each shipment must have freight handling services on order and a completed Bill of Lading in order to ship materials from the show. All pieces must be labeled individually. After materials are packed, labeled and ready to be shipped, the completed Bill of Lading must be turned in at the Valley Service Desk. **Do not leave this in your booth with your shipment.** Call your designated carrier with pick-up information. In the event your carrier fails to show by carrier check in time indicated on the shipping information form, your shipment will be rerouted to Valley Expo & Displays' official show carrier at exhibitor's expense.

#### Tear Down

The show closes at **1:30PM** on **6/13/2018**. Please do not tear down prior to the close of the show. Empty crates will be brought to your booth after Aisle carpet is removed.

#### Outbound Pick-Up Address & Carrier Check In

- All outbound shipments must be picked up at the show site location.
- Each exhibitor is responsible for arranging prompt pick-up and removal of outbound shipments. If you are using a carrier other than the official show carrier, it is your responsibly to contact the carrier and advise them that they must be checked in and the appropriate times.
- Drivers are placed in line for loading on a first-come, first serve basis, provided the exhibitor is completely packed and a Bill of Lading has been turned into the Service Desk. Should your carrier fail to check in by the designated time, Valley Expo & Displays reserves the right to re-route the shipment via the official show carrier as necessary, at the exhibitor's expense.

**Carrier check in Date and Time: 6/13/2018; 3:30PM**

#### Outbound Bill of Lading

- All outbound shipments require a Valley Bill of Lading. Bills of Lading will be distributed to your booth before move out. If you do not receive a bill of lading please see the Valley Service Desk
- A Bill of Lading must be completed for each truckload and destination. If you have multiple shipping destinations or multiple truckloads to one destination, additional Bill of Lading are available at the valley Service Desk.
- No Bill of Lading will be issued until your invoice has been paid in full.
- Return the completed Bill of Lading to the Valley Service Desk when your materials are packaged and ready to be shipped.
- The name of the carrier listed on your completed Bill of Lading must match the name of the carrier checking in or your freight will not be released.

#### Outbound Miscellaneous Services

Shrink Wrap \$ 77.25 per pallet + dismantle labor (please see labor order form for dismantle labor rates)  
 Banding \$ 1.30 per foot + dismantle labor (please see labor order form for dismantle labor rates)

#### Labels

Each individual item in your shipment must be clearly labeled. Blank labels are available at the Valley Service Desk.





Register Here for Online Ordering...  
 www.valleyexpodisplays.com  
 EMAIL: EVENTS@VALLEYEXPODISPLAYS.COM  
 FAX: 815.873.1544

**OUTBOUND  
 BILL OF LADING  
 INSTRUCTION**

**BILL OF LADING INSTRUCTIONS**

These instructions are designed to clarify information required on a Bill of Lading.  
**COMPLETE ALL THE BLUE SHADED AREAS - PRESS HARD**

**The Show Name**      **Today's Date**

The booth number you are exhibiting under. This is where Valley physically looks for your shipment, therefore, the correct booth number is critical.

Circle the total number of bills of lading that will be completed for your booth space. Separate bills must be completed for different destinations and for different methods of shipping. (ie YRC, FedEx, van line, etc.)

The company name you are exhibiting under. The name of this convention center or exhibit hall, including city and state.

List the name of the carrier you have chosen to ship your freight.

If you have selected a carrier other than our house carrier, you must initial here. This informs Valley what to do with your freight in the event your carrier does not check in by the designated time.

What does your shipment consist of? Fill in the exact quantities of each "kind of package" be very specific include weights.

Name and address of the party responsible for the freight charges.

Check "Collect" if the "Ship To" address and the "Freight charges guaranteed by" addresses are the same. If the addresses are different, then you have involved a third party and the "Prepaid/3rd Party" option should be selected.

Please read the Liability on the reverse side of the bill of lading prior to signing. Once you understand and agree to these conditions, please sign and print your name.

**RETURN TO THE VALLEY SERVICE DESK AFTER YOUR MATERIALS ARE PACKED AND READY TO BE SHIPPED. DO NOT TURN THE BILL OF LADING IN EARLY.**

**A SHIPPING LABEL MUST BE PLACED ON EACH PIECE.**

**LEAVE YOUR PACKED SHIPMENT IN YOUR BOOTH.**





Register Here for Online Ordering...  
[www.valleyexpodisplays.com](http://www.valleyexpodisplays.com)  
 EMAIL: [EVENTS@VALLEYEXPDISPLAYS.COM](mailto:EVENTS@VALLEYEXPDISPLAYS.COM)  
 FAX: 815.873.1544

**VEHICLE PLACEMENT  
ORDER FORM**

**International Fuel Ethanol Workshop & Expo 2018  
 Century Link Center Omaha, June 11 - 13, 2018**

Valley Expo & Displays charges a round-trip fee of **\$250.75** per vehicle to place a vehicle on the tradeshow floor. It is understood that this will apply to rolling stock, self-propelled, towed and/or pushed vehicles/machinery. Valley personnel will receive equipment at show site and drive to the exhibitor booth. We will also handle the outbound as an inclusive service.

The City Fire Marshall requires disconnecting the battery, sealing the gas tank and placing a protective covering under the vehicle. Check local Fire Marshal rules and regulations for additional requirements.

Be advised that if you are planning to display a vehicle, you are required to provide the information listed on this page.

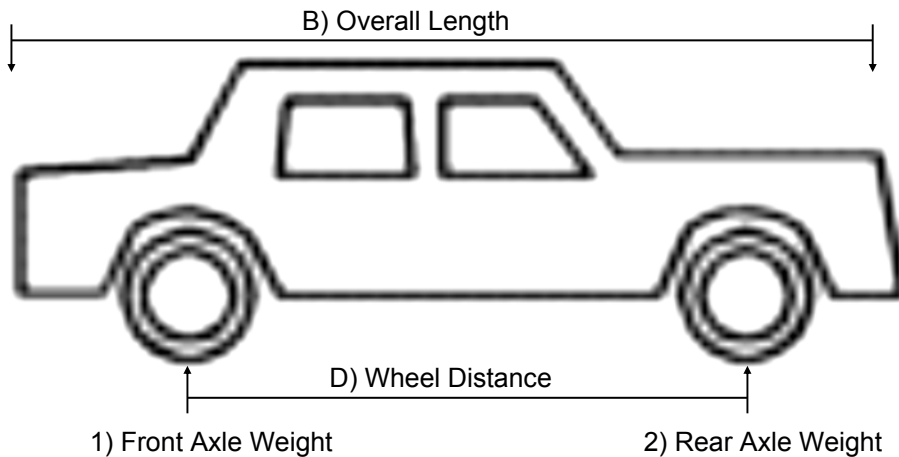

BOOTH NUMBER: \_\_\_\_\_

COMPANY NAME: \_\_\_\_\_

Vehicle Description	A) Overall Width	B) Overall Length	Total Sq. Ft.	C) Wheel Distance	D) Wheel Distance	1) Front Axle Wgt.	2) Rear Axle Wgt.	Total Weight	Total Price
									\$
									\$
									\$
									\$

\* For dual axle vehicles measure distance from the front wheel to between the back wheels

<b>Total Due</b>	<b>\$</b>
------------------	-----------





Register Here for Online Ordering...  
[www.valleyexpodisplays.com](http://www.valleyexpodisplays.com)  
 EMAIL: [EVENTS@VALLEYEXPDISPLAYS.COM](mailto:EVENTS@VALLEYEXPDISPLAYS.COM)  
 FAX: 815.873.1544

## PORTABLE MODULAR DISPLAY RENTAL

### International Fuel Ethanol Workshop & Expo 2018 Century Link Center Omaha, June 11 - 13, 2018

ADVANCE PRICE DEADLINE:  
May 18, 2018

All orders subject to availability of equipment. Rental includes delivery to booth, installation and dismantle of exhibit. Electrical service and labor to install lights are not included.

**Graphics Sold Separately:** Headers do not include graphics. Headers can be one color or full four color digital process. There are several graphic options; Headers, Small panels, Backlit panels, Full length panels. Design is available and all proofing can be done via Email. Call (877) 332-4292 for all services available. Graphics taxes and shipping out after the show are not included.

	Kit#	Description	Advance	Floor	Sale Price
Miscellaneous	115	Capsule Counter	\$ 398.00	\$ 517.00	\$ 1592.00
	129	Fan Counter	\$ 701.00	\$ 911.00	\$ 2804.00
	130	1 Meter Counter	\$ 550.00	\$ 715.00	\$ 2200.00
	131	2 Meter Counter	\$ 750.00	\$ 975.00	\$ 3000.00
	135	Rectangle Counter	\$ 462.00	\$ 600.00	\$ 1848.00
	137	Rectangle Counter w/Display	\$ 550.00	\$ 715.00	\$ 2200.00
	138	Full View Display Counter	\$ 650.00	\$ 845.00	\$ 2600.00
	139	Pedestal	\$ 360.00	\$ 468.00	\$ 1440.00
	LIT	Literature Rack	\$ 120.00	\$ 156.00	\$ 460.00
		IPAD	iPad Stand	\$ 175.00	\$ 228.00
10' x 10' Displays	1160*	Inline Table Top Pop Up	\$ 525.00	\$ 683.00	\$ 2100.00
	1000*	Inline Floor Standing Pop Up	\$ 973.00	\$ 1265.00	\$ 3892.00
	1001*	Inline Floor Standing Pop Up w/Counter	\$ 1259.00	\$ 1637.00	\$ 5036.00
	1102	Inline Floor Standing Hardwall	\$ 1414.00	\$ 1838.00	\$ 5656.00
	1127	Inline Floor Standing Hardwall w/Counter	\$ 2104.00	\$ 2735.00	\$ 8416.00
10' x 20' Displays	2184*	Inline 20 Ft Fabric	\$ 4632.00	\$ 6022.00	\$ 18528.00
	2192*	Inline 20 Ft Serpentine Pop Up	\$ 1607.00	\$ 2089.00	\$ 6428.00
	2193*	Inline 20 Ft Hybrid	\$ 3683.00	\$ 4788.00	\$ 14732.00
	2212	Inline 20 Ft Hardwall	\$ 4255.00	\$ 5531.00	\$ 17020.00
	2367	Inline 20 Ft Hardwall w/Counter	\$ 3530.00	\$ 4589.00	\$ 14120.00
20' x 20' Displays	4087*	Island 20 x 20 Ft Display	\$ 6617.00	\$ 8602.00	\$ 26468.00
	4541*	Island 20 x 20 Ft Display	\$ 7366.00	\$ 9576.00	\$ 29464.00
	4744*	Island 20 x 20 Ft Display	\$ 6209.00	\$ 8072.00	\$ 24836.00

Kit # 1160 includes draped table (circle color) Blue White Gold Green Black Burgundy Red Teal Silver Purple

All 10' x 10', 10' x 20' and 20' x 20' Display kits includes a Standard Carpet (circle color)

Blue Red Grey Green Burgundy Black

\*Kits that include lighting

Kit #	Qty	Price	Optional Graphic	
			Yes	No
		\$	\$	







Register Here for Online Ordering...  
[www.valleyexpodisplays.com](http://www.valleyexpodisplays.com)  
 EMAIL: [EVENTS@VALLEYEXPDISPLAYS.COM](mailto:EVENTS@VALLEYEXPDISPLAYS.COM)  
 FAX: 815.873.1544

**PORTABLE MODULAR  
 DISPLAY DESCRIPTION  
 KIT 115, 129, & 130**

## International Fuel Ethanol Workshop & Expo 2018 Century Link Center Omaha, June 11 - 13, 2018

### Counter Kit 115 Capsule counter

- Freestanding counter constructed of lower Velcro compatible black fabric panels, black laminate top and locking storage.
- Dimensions approximately: 38.11"wide x 20"deep x 40"high
- All Rentals include: Material handling, installation and dismantle of exhibit only.
- Optional front graphic 20"wide x 30"high. Additional cost \$90.00

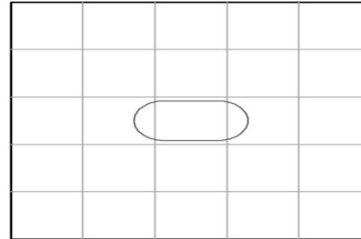

### Counter Kit 129 Fan counter

- Freestanding counter constructed of aluminum extrusion gray base panels and black laminate top with locking storage.
- Overall dimensions approximately: 64.75"wide x 33.407"deep x 40" high
- All Rentals include: Material handling, installation and dismantle of exhibit only.
- Optional front graphic 60.75"wide x 36.25"high. Additional cost \$379.00

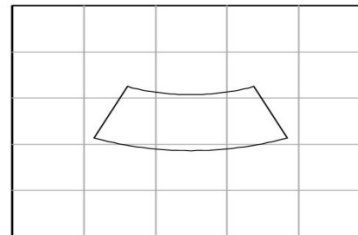

### Counter Kit 130 1 Meter counter

- Freestanding counter constructed of aluminum extrusion gray base panels and black laminate top and locking storage.
- Dimensions: 38.25"wide x 18.875" deep x 40"high
- All Rentals include: Material handling, installation and dismantle of exhibit only.
- Optional front graphic 38.125"wide x 36.25"high. Additional cost \$240.00

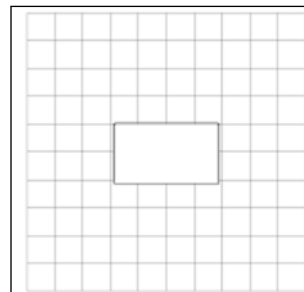





Register Here for Online Ordering...  
[www.valleyexpodisplays.com](http://www.valleyexpodisplays.com)  
 EMAIL: [EVENTS@VALLEYEXPDISPLAYS.COM](mailto:EVENTS@VALLEYEXPDISPLAYS.COM)  
 FAX: 815.873.1544

**PORTABLE MODULAR  
 DISPLAY DESCRIPTION  
 KIT 131, 135, & 137**

## International Fuel Ethanol Workshop & Expo 2018 Century Link Center Omaha, June 11 - 13, 2018

### Counter Kit 131 2 Meter counter

- Freestanding counter constructed of aluminum extrusion gray base panels and black laminate top and locking storage.
- Dimensions: 76" wide x 18.875" deep x 40" high
- All Rentals include: Material handling, installation and dismantle of exhibit only.
- Optional 2 front graphic 38.125" wide x 36.25" high. Additional cost for both \$480.00

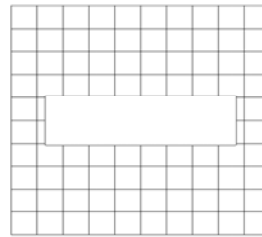

### Counter Kit 135 Rectangle counter

- Freestanding counter constructed of aluminum extrusion gray base panels and black laminate top and locking storage.
- Dimensions: 48" wide x 24" deep x 40" high
- All Rentals include: Material handling, installation and dismantle of exhibit only.
- Optional front graphic 38.25" wide x 32.25" high. Additional cost \$212.00

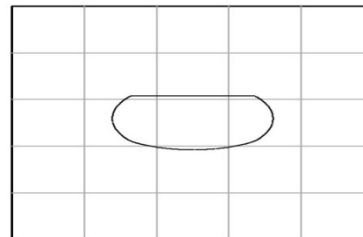

### Counter Kit 137 Rectangle counter with display case top

- Freestanding counter constructed of aluminum extrusion gray base panels and a clear plex top section and locking storage.
- Dimensions: 38.25" wide x 18.875" deep x 40" high
- All Rentals include: Material handling, installation and dismantle of exhibit only.
- Optional front graphic 38.25" wide x 25.75" high. Additional cost \$169.00

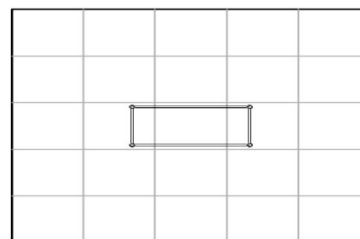



Register Here for Online Ordering...  
[www.valleyexpodisplays.com](http://www.valleyexpodisplays.com)  
 EMAIL: [EVENTS@VALLEYEXPDISPLAYS.COM](mailto:EVENTS@VALLEYEXPDISPLAYS.COM)  
 FAX: 815.873.1544

**PORTABLE MODULAR  
 DISPLAY DESCRIPTION  
 KIT 138, 139, & LIT**

## International Fuel Ethanol Workshop & Expo 2018 Century Link Center Omaha, June 11 - 13, 2018

### Counter Kit 138 Full View display case

- Freestanding case has plex top, front, sides with two interior plexi shelves, lights and locks.
- Dimensions approximately: 72"wide x 24"deep x 40"high
- All Rentals include: Material handling, installation and dismantle of exhibit only.

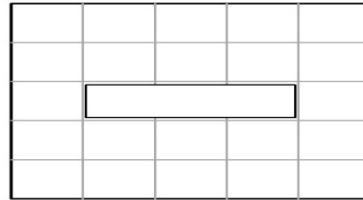

### Pedestal Kit 139

- Freestanding counter constructed of white laminate base, black laminate top and locking storage.
- Dimensions approximately: 30"wide x 36"deep x 40"high
- All Rentals include: Material handling, installation and dismantle of exhibit only.

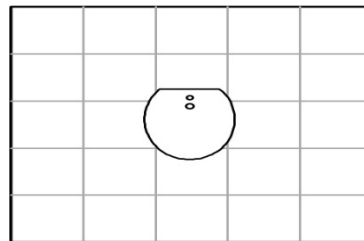

### Literature Rack

- Freestanding silver finish accordion style literature rack with 6 pockets 12 1/8" x 9" x 1" each.
- Dimensions approximately: 11"wide x 15"deep x 60"high
- All Rentals include: Material handling, installation and dismantle of exhibit only.

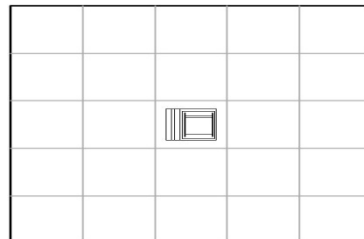



Register Here for Online Ordering...  
[www.valleyexpodisplays.com](http://www.valleyexpodisplays.com)  
 EMAIL: [EVENTS@VALLEYEXPDISPLAYS.COM](mailto:EVENTS@VALLEYEXPDISPLAYS.COM)  
 FAX: 815.873.1544

**PORTABLE MODULAR  
 DISPLAY DESCRIPTION**  
 Stand, 1160, & 1000

## International Fuel Ethanol Workshop & Expo 2018 Century Link Center Omaha, June 11 - 13, 2018

### iPad Stand

- Freestanding silver finish iPad stand with lock and power cord access. iPad NOT included.
- Dimensions approximately: 15.3"wide x 15.5"deep x 54.3"high
- All Rentals include: Material handling, installation and dismantle of exhibit only.

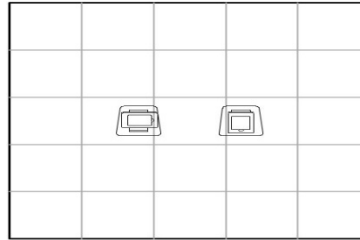

### Inline Kit 1160 Table Top Pop-up Display

- Classic expandable frame covered with black (Velcro compatible) fabric panels, one halogen stem light and one 6ft skirted table included.
- Dimensions approximately: 60" x 60"
- Standard table skirt color selection
- Standard carpet color selection
- All Rentals include: Material handling, installation and dismantle of exhibit only.
- NOT Included: Electronic/audio visual equipment, padding/visqueen, electrical service and electrical labor to install lights. Graphics sold separately. Call for quote.

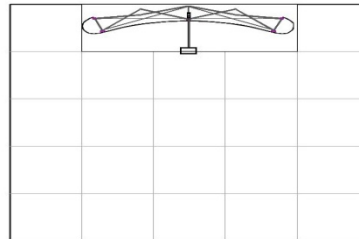

### Inline Kit 1000 Floor Standing Pop-up Display

- Classic expandable frame covered with (Velcro compatible) black fabric panels, two halogen stem lights.
- Dimensions approximately: 10ft wide x 8ft high
- Standard carpet color selection
- All Rentals include: Material handling, installation and dismantle of exhibit only.
- NOT Included: Electronic/audio visual equipment, padding/visqueen, electrical service and electrical labor to install lights. Graphics sold separately. Call for quote.

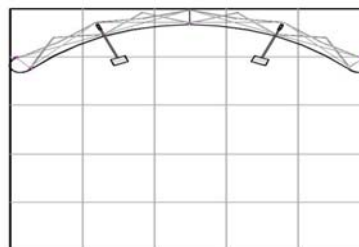
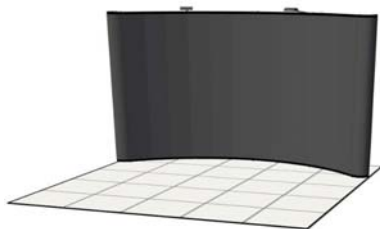



Register Here for Online Ordering...  
[www.valleyexpodisplays.com](http://www.valleyexpodisplays.com)  
 EMAIL: [EVENTS@VALLEYEXPDISPLAYS.COM](mailto:EVENTS@VALLEYEXPDISPLAYS.COM)  
 FAX: 815.873.1544

**PORTABLE MODULAR  
 DISPLAY DESCRIPTION  
 KIT 1001 & 1002**

## International Fuel Ethanol Workshop & Expo 2018 Century Link Center Omaha, June 11 - 13, 2018

### Inline Kit 1001 Floor Standing Pop-up Display

- Classic expandable frame covered with (Velcro compatible) black fabric panels, two halogen stem lights. Includes counter.
- Dimensions approximately: 10ft wide x 8ft high
- Standard carpet color selection
- All Rentals include: Material handling, installation and dismantle of exhibit only.
- NOT Included: Electronic/audio visual equipment, padding/visqueen, electrical service and electrical labor to install lights. Graphics sold separately. Call for quote.

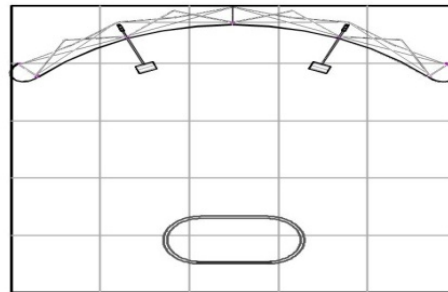
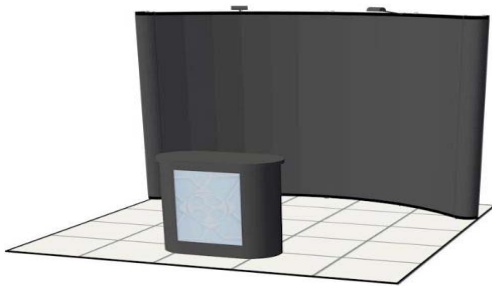

### Inline Kit 1102 (DK 102) Floor Standing Hardwall Display

- Aluminum extrusion frame with cool gray sintra infill panels
- Dimensions approximately: 10ft wide x 8ft high
- Standard carpet color selection
- All Rentals include: Material handling, installation and dismantle of exhibit only.
- NOT Included: Electronic/audio visual equipment, padding/visqueen
- Optional front header graphic 117" wide x 12" high. Additional cost \$244.00

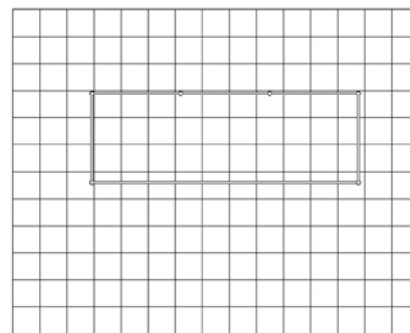



Register Here for Online Ordering...  
[www.valleyexpodisplays.com](http://www.valleyexpodisplays.com)  
 EMAIL: [EVENTS@VALLEYEXPDISPLAYS.COM](mailto:EVENTS@VALLEYEXPDISPLAYS.COM)  
 FAX: 815.873.1544

**PORTABLE MODULAR  
 DISPLAY DESCRIPTION  
 KIT 1127, & 2184**

## International Fuel Ethanol Workshop & Expo 2018 Century Link Center Omaha, June 11 - 13, 2018

### Inline Kit 1127 (DK 127) Floor Standing Hardwall Display

- Aluminum extrusion frame with cool gray sintra infill panels
- 1 meter back wall counter with sliding doors
- 1 meter shelf
- Dimensions approximately: 10ft wide x 8ft high
- Standard carpet color selection
- All Rentals include: Material handling, installation and dismantle of exhibit only.
- NOT Included: Electronic/audio visual equipment, padding/visqueen
- Optional front header graphic 117" wide x 12" high. Additional cost \$244.00

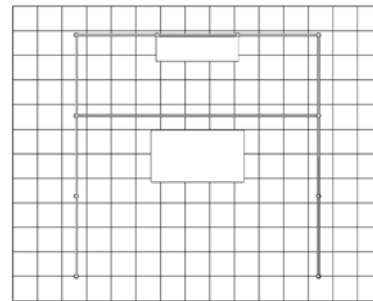

### Inline Kit 2184 20ft Valley Fabric Display

- Brushed aluminum extrusion with a rigid two piece center graphic, two side fabric graphics, three black canopies with lighting and black side wings. Includes counter kit 129.
- Dimensions approximately: 20ft wide x 8ft high
- Standard carpet color selection
- All Rentals include: Material handling, installation and dismantle of exhibit only.
- NOT Included: Electronic/audio visual equipment, padding/visqueen, electrical service and electrical labor to install lights.
- Graphics sold separately. Graphic package as shows \$2,689.00

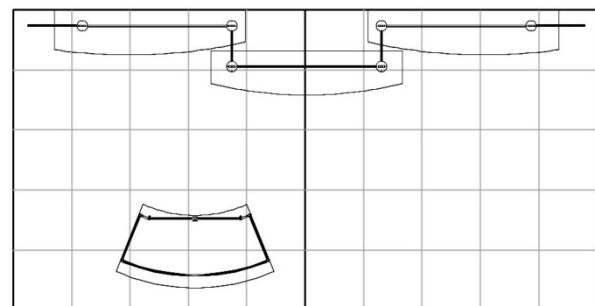



Register Here for Online Ordering...  
[www.valleyexpodisplays.com](http://www.valleyexpodisplays.com)  
 EMAIL: [EVENTS@VALLEYEXPDISPLAYS.COM](mailto:EVENTS@VALLEYEXPDISPLAYS.COM)  
 FAX: 815.873.1544

**PORTABLE MODULAR  
 DISPLAY DESCRIPTION  
 KIT 2192 & 2193**

## International Fuel Ethanol Workshop & Expo 2018 Century Link Center Omaha, June 11 - 13, 2018

### Inline Kit 2192 20ft Serpentine Pop-up Display

- Classic expandable frame covered with (Velcro compatible) black fabric panels, set in a serpentine configuration with four halogen stem lights. Includes counter kit 115.
- Dimensions approximately: 20ft wide x 8ft high
- Standard carpet color selection
- All Rentals include: Material handling, installation and dismantle of exhibit only.
- NOT Included: Electronic/audio visual equipment, padding/visqueen, electrical service and electrical labor to install lights.
- Graphics sold separately. Call for quote.

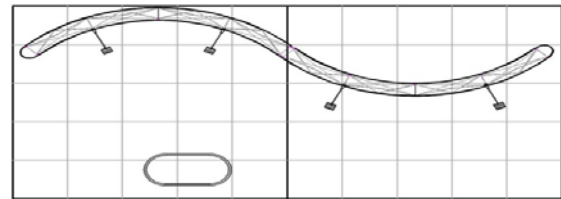
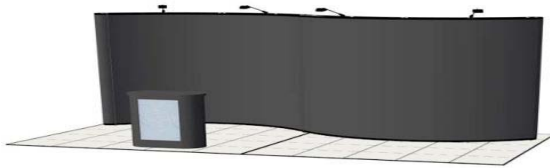

### Inline Kit 2193 20ft Hybrid Display

- Expandable frame covered with black (Velcro compatible) fabric panels, two halogen stem lights in the center flanked by aluminum structure and rigid infill panels. Includes counter kit 135.
- Dimensions approximately: 20ft wide x 8ft high
- Standard carpet color selection
- All Rentals include: Material handling, installation and dismantle of exhibit only.
- NOT Included: Electronic/audio visual equipment, padding/visqueen, electrical service and electrical labor to install lights. Graphics sold separately. Graphic package as shows \$5,641.00

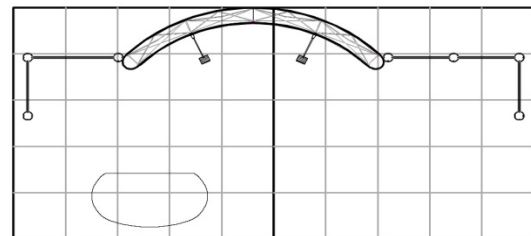





Register Here for Online Ordering...  
[www.valleyexpodisplays.com](http://www.valleyexpodisplays.com)  
 EMAIL: [EVENTS@VALLEYEXPDISPLAYS.COM](mailto:EVENTS@VALLEYEXPDISPLAYS.COM)  
 FAX: 815.873.1544

## PORTABLE MODULAR DISPLAY DESCRIPTION KIT 2212 & 2367

### International Fuel Ethanol Workshop & Expo 2018 Century Link Center Omaha, June 11 - 13, 2018

#### Inline Kit 2212 (DK212) 20ft Hardwall Display

- Aluminum extrusion frame with cool gray sintra infill panels
- 2 meter back wall counter with sliding doors
- Dimensions approximately: 20ft wide x 8ft high
- Standard carpet color selection
- All Rentals include: Material handling, installation and dismantle of exhibit only.
- NOT Included: Electronic/audio visual equipment, padding/visqueen.
- Optional 3 piece front header graphic. Each piece 72" wide x 12" high. Additional cost for all pieces \$450.00

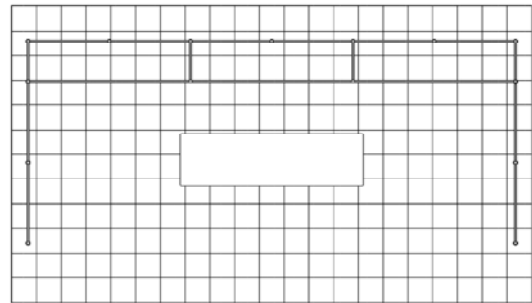

#### Inline Kit 2367 (DK367) 20ft Hardwall Display

- Aluminum extrusion frame with cool gray sintra infill panels
- 2 meter back wall counter with sliding doors
- (2) 2 meter shelves
- Dimensions approximately: 20ft wide x 8ft high
- Standard carpet color selection
- All Rentals include: Material handling, installation and dismantle of exhibit only.
- NOT Included: Electronic/audio visual equipment, padding/visqueen
- Optional 2 piece front header graphic. Each piece 117" wide x 12" high. Additional cost for all pieces \$488.00

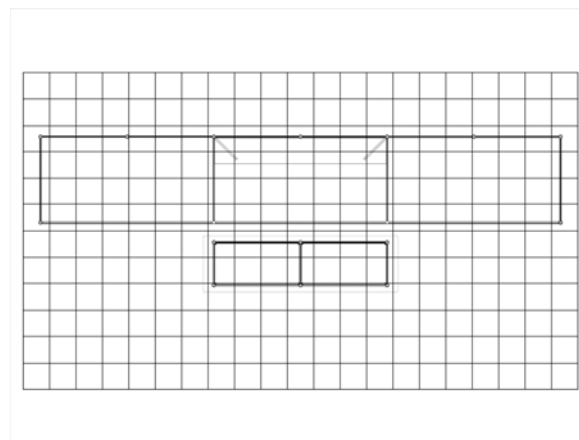



Register Here for Online Ordering...  
[www.valleyexpodisplays.com](http://www.valleyexpodisplays.com)  
 EMAIL: [EVENTS@VALLEYEXPDISPLAYS.COM](mailto:EVENTS@VALLEYEXPDISPLAYS.COM)  
 FAX: 815.873.1544

**PORTABLE MODULAR  
 DISPLAY DESCRIPTION  
 KIT 4087 & 4541**

## International Fuel Ethanol Workshop & Expo 2018 Century Link Center Omaha, June 11 - 13, 2018

### Island Kit 4087 20ft x 20ft Island Display (Innovative Control Solutions)

- Brushed aluminum extrusion creating a center tower and two side panels with gray infill panels. Includes six stem lights, one counter kit 129, one standard 36" x 30" café table and four standard side chairs.
- Dimensions approximately: 20ft x 20ft x 12ft or 16ft high
- Standard carpet color selection
- All Rentals include: Material handling, installation and dismantle of exhibit only.
- NOT Included: Electronic/audio visual equipment, padding/visqueen, electrical service and electrical labor to install lights.
- Graphics sold separately. Graphic package as shows \$4,627.

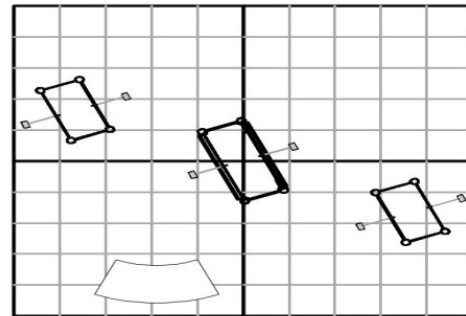

### Island Kit 4541 20ft x 20ft Island Display

- Brushed aluminum extrusion creating a corner storage closet, with four stem lights. A aluminum curved header, four workstations gray base panels, black laminate top with monitor mounting brackets and storage. One counter kit 129.
- Dimensions approximately: 20ft x 20ft x 12ft or 16ft high
- Standard carpet color selection
- All Rentals include: Material handling, installation and dismantle of exhibit only.
- NOT Included: Electronic/audio visual equipment, padding/visqueen, electrical service and electrical labor to install lights. Graphics sold separately. Graphic package as shows \$5,958.00

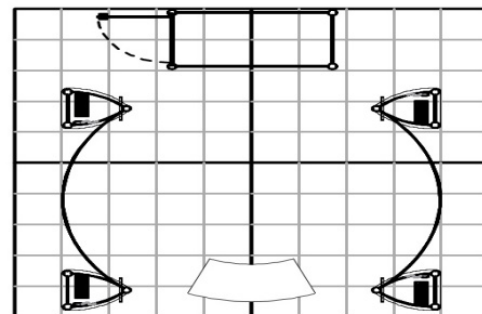
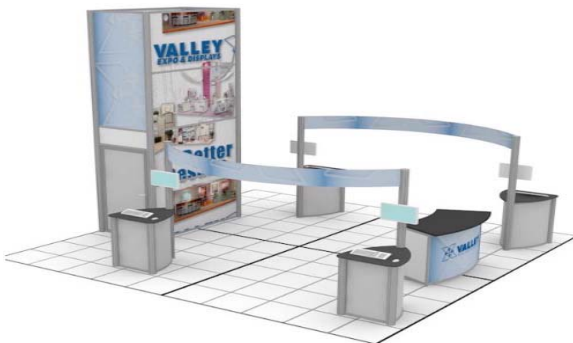



Register Here for Online Ordering...  
[www.valleyexpodisplays.com](http://www.valleyexpodisplays.com)  
 EMAIL: [EVENTS@VALLEYEXPODISPLAYS.COM](mailto:EVENTS@VALLEYEXPODISPLAYS.COM)  
 FAX: 815.873.1544

**PORTABLE MODULAR  
 DISPLAY DESCRIPTION  
 KIT 4744**

**International Fuel Ethanol Workshop & Expo 2018  
 Century Link Center Omaha, June 11 - 13, 2018**

**Island Kit 4744 20ft x 20ft Island Display**

- Brushed aluminum extrusion creating a round center tower. Two curved side wings with one workstation, gray base panels, black laminated top, on each end with storage. Includes four stem lights and one counter kit 129,
- Dimensions approximately: 20ft x 20ft x 12ft or 16ft high
- Standard carpet color selection
- All Rentals include: Material handling, installation and dismantle of exhibit only.
- NOT Included: Electronic/audio visual equipment, padding/visqueen, electrical service and electrical labor to install lights. Graphics sold separately. Graphic package as shows \$7,279.00

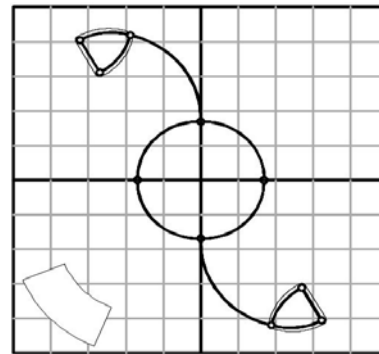



Register Here for Online Ordering...  
 www.valleyexpodisplays.com  
 EMAIL: EVENTS@VALLEYEXPODISPLAYS.COM  
 FAX: 815.873.1544

**EVENT LABOR EXHIBITOR SUPERVISED ORDER FORM**

**International Fuel Ethanol Workshop & Expo 2018**  
**Century Link Center Omaha, June 11 - 13, 2018**

ADVANCE PRICE DEADLINE:  
 May 18, 2018

**Orders with payment in full must be received by May 18, 2018, for Advance Prices.**

All installation and dismantling work will be performed under the direction of exhibitor supervising qualified personnel in compliance with any applicable labor contracts. If you wish to hire Valley Expo & Displays to supervised work performed, please complete the Valley Supervised Labor form.

**Rate Information**

Description	Advance	Floor
<b>Straight Time</b> - 8:00 AM and 4:30 PM on weekdays	\$ 146.95	\$ 191.05
<b>Overtime</b> - before 8:00 am and after 4:30 pm on weekdays and all day Saturday	\$ 220.43	\$ 286.58
<b>Double time</b> - All day Sunday and holidays	\$ 293.90	\$ 382.10

A minimum charge of one (1) hour per man will apply to all labor orders, with the time commencing upon assignment of labor in accordance with your order. Half (1/2) hour minimum per man is charged thereafter.

Labor must be cancelled in writing 24 hours in advance to avoid a one (1) hour cancellation fee per worker.

We will attempt whenever possible to perform the work on straight time, contingent upon the schedules of the show producer and/or convention facility.

**Labor check in & Out**

Exhibitor must check in at the Valley Service Desk to pick up laborers. Upon completion of work, exhibitors must return to the Valley Service Desk to release laborers and to sign the work order indicating the labor completed. Failure to pick up labor at the Valle Service Desk will result in a one (1) hour per man no show charge.

**Hours of Operation**

When scheduling dismantle, be sure to allow sufficient time for empty containers to be returned to your booth

Move In Dates & Times

6/10/2018; 8:00AM - 5:00PM  
 6/11/2018; 8:00AM - 12:00PM

Move Out Dates & Times

6/13/2018; 1:30PM - 6:30PM

**Requesting Times**

Time can only be guaranteed at the start of the working day (8:00AM), or the official beginning of set up, if later in the day. We will make every attempt to provide labor at times subsequent to 8:00 AM (or start of official set up); however, such starting times are approximate as they are dependent up on completion times of prior job assignments.

Requesting Date & Time	Date Labor Requested	Time Labor Requested
Installation		AM or PM
Dismantle		AM or PM
Requested starting times cannot be guaranteed, however, every effort is made to meet all request		

**Description of labor requested**

**MUST** provide brief description of labor requested (e.g. lay carpet, install pop-up)

**Estimate of Charges**

Computation of Labor Charges	# of Workers X	# Hours X	Labor Rate	Total Estimate
Installation			\$	\$
Dismantling			\$	\$

**Authorization to Provide Labor Services:** By completing the Event Labor Form, it is understood that Valley Expo & Displays and its subcontractors do not automatically insure materials, that insurance, if any, shall be arranged by the Exhibitor and the amounts payable to Valley Expo & Displays for labor services are based on the value of the services rendered and the scope of Valley Expo & Displays' liability as herein set forth. The amounts payable to Valley Expo & Displays are unrelated to the value of the Exhibitor's property being handled by Valley Expo & Displays or its subcontractors. It is impractical and extremely difficult to fix the value of each item handled by Valley Expo & Displays or its subcontractors. It is agreed therefore that if Valley Expo & Displays or its subcontractors should be found liable for loss or damage to Exhibitor's materials, the liability shall be limited to the specific article that was physically lost or damaged. Such liability shall be limited to a sum less than or equal to the charges for services rendered as agreed upon damages, and such agreed upon damages shall be the Exhibitors exclusive remedy.

Exhibiting Company Name:

Booth Number(s)



Register Here for Online Ordering...  
 www.valleyexpodisplays.com  
 EMAIL: EVENTS@VALLEYEXPDISPLAYS.COM  
 FAX: 815.873.1544

**EVENT LABOR  
 VALLEY SUPERVISED  
 ORDER FORM**

**International Fuel Ethanol Workshop & Expo 2018  
 Century Link Center Omaha, June 11 - 13, 2018**

ADVANCE PRICE DEADLINE:  
 May 18, 2018

**Orders with payment in full must be received by May 18, 2018, for Advance Prices.**

**Information & Requirements**

- All work is preformed under the supervision of Valley personal
- Exhibits can be set up prior to your arrival at exhibitor move in
- Exhibitor must forward all necessary instruction, drawing or diagrams in advance with this order

Contact Person: \_\_\_\_\_ Phone: \_\_\_\_\_

Email: \_\_\_\_\_

Freight will be shipped to:  Advance Warehouse  Direct to Show Site

Date Shipped: \_\_\_\_\_ Inbound Carrier: \_\_\_\_\_

**Inbound Shipping & Set Up Information**

Total # of: Crates \_\_\_\_\_ Cartons \_\_\_\_\_ Fiber Cases \_\_\_\_\_ Other \_\_\_\_\_

Setup Plans/Photo:  Attached to order  To be sent with Exhibit, in crate # \_\_\_\_\_  Sent to events@valleyexpodisplays.com

Flooring/Carpet:  With exhibit  Rented from Valley

Electrical Placement:  Electrical under carpet  Electrical in back of booth  Other, must provide floor plan

Graphic:  With exhibit  Shipped separately

Special Tools/Hardware/Equipment Required: \_\_\_\_\_

Ship to: \_\_\_\_\_

\_\_\_\_\_

\_\_\_\_\_

**Outbound Shipping Information**

Method of shipment: Common Carrier \_\_\_\_\_  UPS  FedEx  Show Carrier

If labels are provided where will they be: \_\_\_\_\_

Freight Charges:  Prepaid  Collect

Bill to: \_\_\_\_\_

\_\_\_\_\_

**A minimum charge** of one (1) hour per man will apply to all labor orders, with the time commencing upon assignment of labor in accordance with your order. Half (1/2) hour minimum per man is charged thereafter.

Labor must be cancelled in writing 24 hours in advance to avoid a one (1) hour cancellation fee per worker.

**Rate Information**

We will attempt whenever possible to perform the work on straight time, contingent upon the schedules of the show producer and/or convention facility.

Description	Advance	Floor
<b>Straight Time</b> - 8:00 AM and 4:30 PM on weekdays	\$ 146.95	\$ 191.05
<b>Overtime</b> - before 8:00 am and after 4:30 pm on weekdays and all day Saturday	\$ 220.43	\$ 286.58
<b>Double time</b> - All day Sunday and holidays	\$ 293.90	\$ 382.10

**Description of labor requested**

\_\_\_\_\_  
 \_\_\_\_\_

**Estimate of Charges**

Computation of Labor Charges	# of Workers X	# Hours X	Labor Rate	Total Estimate
Installation			\$	\$
Dismantling			\$	\$

**Authorization to Provide Labor Services:** By completing the Event Labor Form, it is understood that Valley Expo & Displays and its subcontractors do not automatically insure materials, that insurance, if any, shall be arranged by the Exhibitor and the amounts payable to Valley Expo & Displays for labor services are based on the value of the services rendered and the scope of Valley Expo & Displays' liability as herein set forth. The amounts payable to Valley Expo & Displays are unrelated to the value of the Exhibitor's property being handled by Valley Expo & Displays or its subcontractors. It is impractical and extremely difficult to fix the value of each item handled by Valley Expo & Displays or its subcontractors. It is agreed therefore that if Valley Expo & Displays or its subcontractors should be found liable for loss or damage to Exhibitor's materials, the liability shall be limited to the specific article that was physically lost or damaged. Such liability shall be limited to a sum less than or equal to the charges for services rendered as agreed upon damages, and such agreed upon damages shall be the Exhibitors exclusive remedy.

Exhibiting Company Name: \_\_\_\_\_

Booth Number(s) \_\_\_\_\_





Register Here for Online Ordering...  
 www.valleyexpodisplays.com  
 EMAIL: EVENTS@VALLEYEXPDISPLAYS.COM  
 FAX: 815.873.1544

**FORKLIFT SERVICE**

**International Fuel Ethanol Workshop & Expo 2018**  
**Century Link Center Omaha, June 11 - 13, 2018**

ADVANCE PRICE DEADLINE:  
 May 18, 2018

**PLEASE COMPLETE THIS FORM FOR ALL IN-BOOTH FORKLIFT AND LABOR NEEDED. TO DETERMINE IF YOU NEED IN-BOOTH FORKLIFT AND LABOR, PLEASE READ THIS FORM CAREFULLY.**

- In-Booth Forklift and Labor may be required to assemble displays or when uncrating, positioning, and reskidding equipment and machinery.
- A forklift is required for moving equipment and materials weighing 200 pounds or more within your booth.
- If you require a forklift, a crew will be assigned consisting of a Rigger Foreman and forklift up to 5,000lbs with an operator. Please call for quote if forklift over 5,000lbs is required.

**Forklift time required to move freight to and from the dock to your booth is included in the freight handling charges, refer to Advance or Direct order forms for further information**

All exhibitors requesting labor must go to the Valley Service Desk to confirm labor requests. All labor and equipment requests should be confirmed by 2:00 pm the day prior, with the exception of the first day of move in. Requested starting times cannot be guaranteed, however, every effort is made to meet all requests. Valley reserves the right to dispatch all labor calls based upon availability of labor crews and in the order that the requests are confirmed. Upon completion of work, an exhibitor representative must return to the Valley Service Desk to sign the completed work ticket and confirm accuracy of the work order. No adjustments will be made after the event. Equipment and labor cancelled without a 24 hour notice will be charged a one (1) hour cancellation fee per worker and equipment ordered. If the labor and equipment is not used at the time confirmed, there will be a one (1) hour no-show fee charged per worker and equipment ordered.

**Important Information & Rates**

The minimum charge for labor and equipment is one (1) hour per worker and forklift. Equipment and labor thereafter is charged in half (1/2) hour increments. All rates are subject to change if necessitated by increased labor and material costs.

Description	Advance Rate (per hour)	Floor Rate (per hour)
<b>Straight Time</b> - 8:00 AM and 4:30 PM on weekdays	\$ 369.65	\$ 480.55
<b>Overtime</b> - before 8:00 am and after 4:30 pm on weekdays and all day Saturday	\$ 554.48	\$ 720.83
<b>Double time</b> - All day Sunday and holidays	\$ 739.30	\$ 961.10

When scheduling dismantle, be sure to allow sufficient time for empty containers to be returned to your booth

**Hours of Operation**

Move In Dates & Times

6/10/2018; 8:00AM - 5:00PM  
 6/11/2018; 8:00AM - 12:00PM

Move Out Dates & Times

6/13/2018; 1:30PM - 6:30PM

**Required Information**

Does the weight exceed 5,000lbs  No  Yes, \_\_\_\_\_ total weight

Is there any special handling equipment required to lift materials, i.e. extended forklift blades, special slings, etc.?  No  Yes  
 please describe needs:

INSTALLATION						
Schedule Date(s)	Schedule Start Time	Schedule End Time	Total # of Hours	Total # of Forklifts	Labor Rate	Total
Please Indicate Service to be provided: <input type="checkbox"/> Uncrating <input type="checkbox"/> Leveling <input type="checkbox"/> Unskidding <input type="checkbox"/> Positioning <input type="checkbox"/> Exhibit Construction (describe work below) <input type="checkbox"/> Other						Total
Other: Please describe work						

DISMANTLE						
Schedule Date(s)	Schedule Start Time	Schedule End Time	Total # of Hours	Total # of Forklifts	Labor Rate	Total
Please Indicate Service to be provided: <input type="checkbox"/> Recreating <input type="checkbox"/> Dismantling <input type="checkbox"/> Recreating <input type="checkbox"/> Other						Total
Other: Please describe work						



Register Here for Online Ordering...  
[www.valleyexpodisplays.com](http://www.valleyexpodisplays.com)  
 EMAIL: [EVENTS@VALLEYEXPODISPLAYS.COM](mailto:EVENTS@VALLEYEXPODISPLAYS.COM)  
 FAX: 815.873.1544

**BOOTH & EXHIBIT  
 PORTER SERVICE**

**International Fuel Ethanol Workshop & Expo 2018**  
**Century Link Center Omaha, June 11 - 13, 2018**

ADVANCE PRICE DEADLINE:  
 May 18, 2018

**Orders with payment in full must be received by *May 18, 2018*, for Advance Prices.**

Submit this form if you want to order Valley Expo & Displays cleaning service for your booth in order to maintain booth cleanliness post set-up or throughout the entire event. Prices are based on total square footage of booth regardless of area to be cleaned.

**Standard Booth Size ( 10' x 10' ) = Square Footage ( 100 square feet per booth )**

**Carpet Vacuuming:** Booth carpeting is clean upon installation; however, vacuuming services are available. Charges are based on booth square footage. Display installation can result in soiled carpet; therefore, we recommend ordering vacuuming at least once prior to show opening.

**Carpet  
 Vacuuming**

	Sq. Ft.	X	Advance	Floor	=	Total
Once Prior to Show Opening	_____		\$ 0.50	\$ 0.65		_____
3 Days - Prior to Show Opening Each Day	_____		\$ 1.50	\$ 1.95		_____

**Porter Service:** Includes wipedown & dusting of all display surfaces and furnishings, and emptying of wastebaskets nightly.

**Porter  
 Service**

	Sq. Ft.	X	Advance	Floor	=	Total
Once Prior to Show Opening	_____		\$ 0.55	\$ 0.75		_____
3 Days - Prior to Show Opening Each Day	_____		\$ 1.65	\$ 2.25		_____

Exhibiting Company Name: \_\_\_\_\_

Booth Number(s) \_\_\_\_\_

<b>Subtotal</b>	\$	_____
<b>7% Sales Tax</b>	\$	_____
<b>Total</b>	\$	_____

*Must include Recap of Cost and Payment Form along with order form.*





Register Here for Online Ordering...  
**www.valleyexpodisplays.com**  
 EMAIL: EVENTS@VALLEYEXPDISPLAYS.COM  
 FAX: 815.873.1544

**SIGN & BANNER**

ADVANCE PRICE DEADLINE:  
 May 18, 2018

**International Fuel Ethanol Workshop & Expo 2018**  
**Century Link Center Omaha, June 11 - 13, 2018**

This form can be used to order custom show cards and banners for your exhibit booth. **Custom signs and banners can be ordered in advance only.** We must receive your order with payment by **May 18, 2018**, to guarantee delivery.

Labor to install signs or banners is not included. Please refer to the Event Labor Order Form for assistance in installing your signs if it will be needed. All signs are printed on white background. 10 word limit per sign. Additional words and logos are extra.

**Attach your sign copy to a separate page. Please provide us with a contact name, E-mail address and phone number in case we have questions.**

Contact for sign questions: \_\_\_\_\_

Email: \_\_\_\_\_ Phone: \_\_\_\_\_

Exhibiting Company Name: \_\_\_\_\_

	Description	Quantity	Price	Total
Foamcore Signs White Background One color	11' x 14'	_____	\$ 61.25	_____
	14' x 22'	_____	\$ 85.90	_____
	22" x 28"	_____	\$ 108.70	_____
	28" x 44"	_____	\$ 148.20	_____
Foamcore Signs White Background Two color	22" x 28"	_____	\$ 139.20	_____
	28" x 44"	_____	\$ 179.90	_____
Vinyl Banners White Background Only	2' X 4'	_____	\$ 149.45	_____
	2' X 6'	_____	\$ 179.55	_____
	2' X 8'	_____	\$ 269.90	_____
	Grommets for hanging are included			
Miscellaneous	Easel Back	_____	\$ 11.70	_____
	Logos	_____	\$ Call for Price	_____
	Sign Grommets	_____	\$ 4.30	_____
	Color Background	_____	\$ Add 25%	_____

Booth Number(s) \_\_\_\_\_

Sign copy to be arranged:  Horizontally  Vertically

Color of Printing (one color only): \_\_\_\_\_

Our sign shop can produce any type of sign or banner you need, including multiple colors, photographic reproductions, etc. If an option or feature you want is not listed on this form, please call us for a special quote.

<b>Subtotal</b>	\$	_____
<b>7% Sales Tax</b>	\$	_____
<b>Total</b>	\$	_____

*Must include Recap of Cost and Payment Form along with order form.*





## FLORAL ORDER FORM

<b>Name of Show:</b>			
<b>Location:</b>		<b>Show Dates:</b>	
Exhibitor:		Booth Number:	
Bill to:		Email:	
Address:		City:	State: Zip:
Phone:	Fax:	Company Representative:	
Purchase Order #:	Job #:	Date Ordered:	
COMPLETE THIS BOX ONLY IF DESIGNER IS NEEDED ON SITE			
Booth Contact: _____		Contact Phone: _____ Available Time/Date: _____	

### PAYMENT INFORMATION

Circle one VISA MC AMEX DISCOVER

Name: \_\_\_\_\_

Card #: \_\_\_\_\_

Exp. Date: \_\_\_\_\_ CVV code: \_\_\_\_\_

Signature: \_\_\_\_\_

- Foliage plants and architectural containers on rental basis.
- Price includes: **PLANT INSTALLATION, ARCHITECTURAL CONTAINERS, SERVICING THROUGHOUT THE SHOW, & DISMANTLING AT END OF SHOW**
- **NO ADJUSTMENTS NOR REFUNDS CAN BE MADE AFTER THE SHOW OPENING.**

Quantity	Tropical Plants <i>(Please specify quantity, heights, and variety)</i>	Price	Total
	Potted Ferns	\$66.40	
	2' Plants	\$97.50	
	3' Plants	\$101.05	
	4' Plants	\$116.50	
	5' Plants	\$151.55	
	6'-7' Plants	\$170.00	
	<b>Containers for Plants:</b> Black _____ White _____		
	<i>TALLER PLANTS ARE AVAILABLE, PLEASE INQUIRE IN ADVANCE</i>		
	<b>Blooming Plants</b>		
	Potted Mums <i>(Yellow, White, &amp; Lavender)</i>	\$73.05	
	Potted Azaleas <i>(Red, Pink, &amp; White)</i>	\$73.05	
	Bromeliads	\$73.05	
	<b>Floral Arrangements</b> Please Choose Tropical or Seasonal <i>(Please indicate desired colors)</i> <i>Floral Arrangements are only guaranteed for 3 days</i>		
	Small Arrangement <i>(12"x12")</i>	\$86.50	
	Medium Arrangement <i>(18"x14")</i>	\$110.00	
	Large Arrangement <i>(24"x18")</i>	\$132.50	
		Tax (8%)	
		<b>TOTAL</b>	

Floral Exhibits, Ltd.  
1420 S Rockwell St.  
Chicago, IL 60608

Phone #: 773.277.1888  
Fax #: 773.277.1919  
www.floralexhibits.com

**PLEASE RETAIN A COPY FOR YOUR RECORDS**



Valley Expo & Displays  
Specialty Furnishings







## WHISPER



### Whisper Sofa

White Leather  
87"L x 37"D x 35"H



### Whisper Loveseat

White Leather  
61"L x 37"D x 35"H



### Whisper Chair

White Leather  
35"L x 37"D x 35"H



### Whisper Bench Ottoman

White Leather  
60"L x 24"D x 17"H



### Whisper Square Ottoman

White Leather  
40"Square x 17"H



### Whisper Round Ottoman

White Leather  
46"Round x 17"H

## FUNCTION

Modular Seating Collection



### Function Armless Chair

White Leather  
28"Square x 29"H



### Function Corner

White Leather  
28"Square x 29"H

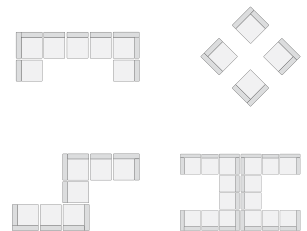

## CONTINENTAL

Modular Seating Collection



### Continental Curved Loveseat

White Leather  
82"L x 34"D x 31"H



### Continental Reverse Curved Loveseat

White Leather  
72"L x 34"D x 31"H



### Continental Wedge Ottoman

White Leather  
30"L x 34"D x 19"H



### Continental Curved Bench Ottoman

White Leather  
70"L x 26"D x 19"H



### Continental Half Moon Ottoman

White Leather  
33"L x 19"D x 19"H

## SOPHISTICATION

Modular Seating Collection



### Sophistication Sofa

White Leather  
72"L x 31"D x 48"H



### Sophistication Loveseat

White Leather  
48"L x 31"D x 48"H



### Sophistication Chair

White Leather  
24"L x 31"D x 48"H

## SOPHISTICATION

Modular Seating Collection



### Sophistication Corner

White Leather  
31"Square x 48"H



### Sophistication Ottoman

White Leather  
31"Square x 19"H

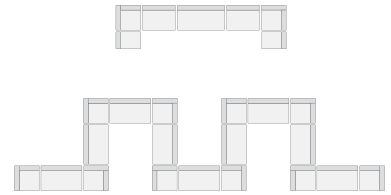

## BOCA

Modular Seating Collection



### Boca Corner

Black Leather  
27"Square x 30"H



### Boca Armless

Black Leather  
22"L x 27"D x 30"H

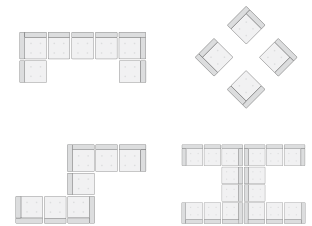

## METRO



### Metro Sofa

Black Leather  
85"L x 35"D x 35"H



### Metro Loveseat

Black Leather  
60"L x 35"D x 35"H



### Metro Chair

Black Leather  
35"Square x 35"H



## METRO



### Metro Square Ottoman

Black Leather  
40"Square x 17"H



### Metro Bench Ottoman

Black Leather  
60"L x 24"D x 17"H

## SUAVE MIDNIGHT



### Suave Midnight Sofa

Midnight Suede  
77"L x 36"D x 33"H



### Suave Midnight Loveseat

Midnight Suede  
54"L x 36"D x 33"H



### Suave Midnight Chair

Midnight Suede  
32"L x 36"D x 33"H

## GRAMMERCY

Modular Seating Collection

\*See page 10 & 11 for additional Grammercy product available



### Grammercy Sofa

Charcoal Leather  
82"L x 36"D x 36"H



### Grammercy Loveseat

Charcoal Leather  
57"L x 36"D x 36"H



### Grammercy Chair

Charcoal Leather  
28"L x 36"D x 36"H

**Grammercy Corner**  
36"Square x 36"H



## PARMA



**Parma Sofa**  
Brown Leather  
79"L x 37"D x 36"H



**Parma Loveseat**  
Brown Leather  
56"L x 37"D x 36"H



**Parma Chair**  
Brown Leather  
33"L x 37"D x 36"H



**Parma Bench Ottoman**  
Brown Leather  
60"L x 24"D x 17"H

## MONTANA MOCHA



**Montana Mocha Sofa**  
Mocha Tan Fabric  
79"L x 35"D x 34"H



**Montana Mocha Loveseat**  
Mocha Tan Fabric  
57"L x 35"D x 34"H



**Montana Mocha Chair**  
Mocha Tan Fabric  
35"Square x 34"H

## CHANDLER



### Chandler Sofa

Red Leather  
76"L x 37"D x 35"H



### Chandler Loveseat

Red Leather  
53"L x 37"D x 35"H



### Chandler Chair

Red Leather  
31"L x 37"D x 35"H



### Chandler Bench Ottoman

Red Leather  
60"L x 24"D x 17"H

## EVOKE



### Evoke Sofa

Coffee Resin Frame with Tan Cushions  
81"L x 35"D x 27"H



### Evoke Chair

Coffee Resin Frame with Tan Cushions  
33"L x 35"D x 27"H

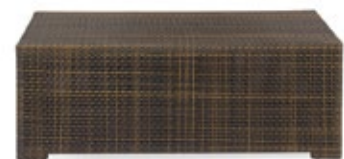

### Evoke Cocktail Table

Coffee Resin Frame  
48"L x 24"D x 18"H

## EVOKE



**Evoke End Table**  
Coffee Resin Frame  
24"L x 28"D x 25"H



**Evoke Cube**  
Coffee Resin Frame  
18"Square

## STAGE CHAIRS



**Midnight Stage Chair**  
Midnight Microfiber  
25"L x 26"D x 37"H



**Chamois Stage Chair**  
Beige Microfiber  
25"L x 26"D x 37"H



**Buckskin Stage Chair**  
Tan Microfiber  
25"L x 26"D x 37"H



**Empire Chair**  
■ Black Leather  
□ White Leather  
28"L x 32"D x 32"H



**Ibiza Chair**  
■ Black Leather  
□ White Leather  
31"L x 35"D x 32"H



**Tulip Chair**  
Black Fabric/Tilt Back/Caster Feet  
27"L x 26"D x 35"H

## STAGE CHAIRS



### Monarch Chair

Bright White Leather  
28"Square x 30"H

## OTTOMANS & BENCHES



### Curved Bench

Continental White Leather  
70"L x 26"D x 19"H



### Square Ottoman

- Metro Black Leather
  - Whisper White Leather
  - Grammercy Charcoal Leather
- 40"Square x 17"H



### Bench Ottoman

- Metro Black Leather
  - Whisper White Leather
  - Chandler Red Leather
  - Grammercy Charcoal Leather
  - Parma Brown Leather
- 60"L x 24"D x 17"H



### Essentials Storage Ottoman

White Leather with Locking Mechanism  
48"L x 24"D x 20"H  
Lock Not Included



### Round Ottoman

- Grammercy Charcoal Leather
  - Whisper White Leather
- 46"Round x 17"H



### 1/4 Round Ottoman

- Grammercy Charcoal Leather
  - Whisper White Leather
- 34"L x 19"D x 17"H

## BANQUETTES



**Essentials Banquette**  
White Leather  
60"Round x 48"H (2 Pieces)



**Whisper Banquette**  
White Leather  
59"Round x 38"H (2 Pieces)



**Grammercy Banquette**  
Charcoal Leather  
59"Round x 38"H (2 Pieces)

## TURNING BEDS



**Essentials Turning Bed**  
White Leather  
96"L x 48"D x 34"H

## CUBE OTTOMANS



**Regency Cube Ottomans**  
From left to right: Orange Fabric, Teal Fabric, Ruby Fabric, Camel Fabric, Apple Fabric, Fuchsia Fabric  
18"Square



## CUBE OTTOMANS



### Cube Ottomans

From left to right: White Leather, Black Leather, Red Vinyl, Green Vinyl, Blue Vinyl, Purple Vinyl  
18" Square



### Essentials Turning Bed - Charged

White Leather  
96"L x 48"D x 25"H

*\*White slip cover available for black charging unit.*



### Boca Corner - Charged

Bright White Leather  
27" Square x 30"H



### Boca Chair - Charged

Bright White Leather  
22"L x 27"D x 30"H



### Aspen Bar Table - Charged

White / Brushed Steel  
72"L x 26"D x 42"H



### Aspen Cocktail Table - Charged

White / Brushed Steel  
48"L x 24"D x 18"H



### White Conference Table - Charged

White  
96"L x 43"D x 30"H

## OCCASIONAL TABLES



### Tribeca Tables

End Table Wood/Black  
24"L x 28"D x 22"H  
Console Table Wood/Black  
48"L x 18"D x 30"H  
Cocktail Table Wood/Black  
48"L x 28"D x 19"H



### Harmony Tables

End Table Wood/Esspresso  
24"Round x 22"H  
Console Table Wood/Esspresso  
52"L x 18"D x 30"H  
Cocktail Table Wood/Esspresso  
51"L x 28"D x 18"H



### Novel Tables

End Table Satin Steel  
15"Square x 16"H  
Cocktail Table Satin Steel  
46"L x 15"D x 16"H



### Aria Tables Red

End Table Red/Brushed Steel  
24"L x 20"D x 22"H  
Cocktail Table Red/Brushed Steel  
44"L x 20"D x 18"H



### Aria Tables Green

End Table Green/Brushed Steel  
24"L x 20"D x 22"H  
Cocktail Table Green/Brushed Steel  
44"L x 20"D x 18"H



### Aria Tables Blue

End Table Blue/Brushed Steel  
24"L x 20"D x 22"H  
Cocktail Table Blue/Brushed Steel  
44"L x 20"D x 18"H



### Aria Tables Purple

End Table Purple/Brushed Steel  
24"L x 20"D x 22"H  
Cocktail Table Purple/Brushed Steel  
44"L x 20"D x 18"H



### Aria Tables White

End Table White/Brushed Steel  
24"L x 20"D x 22"H  
Console Table White/Brushed Steel  
44"L x 20"D x 30"H  
Cocktail Table White/Brushed Steel  
44"L x 20"D x 18"H



### Aria Tables Charcoal

End Table Storm Grey/Brushed Steel  
24"L x 20"D x 22"H  
Console Table Storm Grey/Brushed Steel  
44"L x 20"D x 30"H  
Cocktail Table Storm Grey/Brushed Steel  
44"L x 20"D x 18"H

## OCCASIONAL TABLES



### London Tables

End Table Chrome/Marble  
24" Square x 23"H  
Console Table Chrome/Marble  
60"L x 16"D x 34"H  
Cocktail Table Chrome/Marble  
40" Square x 16"H



### Brooklyn Tables

End Table Square - Chrome  
22" Square x 20"H  
End Table Round - Chrome  
20" Round x 20"H  
Cocktail Table Rectangle - Chrome  
42"L x 24"D x 16"H  
Cocktail Table Round - Chrome  
30" Round x 16"H



### Vivid Tables

End Table - Smoked Powder Coat Finish  
26" Square x 21"H  
Console Table - Smoked Powder Coat Finish  
50"L x 24"D x 30"H  
Cocktail Table - Smoked Powder Coat Finish  
50"L x 24"D x 16"H



### Club Tables

End Table  
44"L x 22"D x 18"H  
Cocktail Table  
22" Square x 18"H  
(Includes built in Wireless LED Lighting)



### Rose Table

17" Round x 17"H



### Zanzibar Table

17" Square



### Cube End Tables

■ Black 24"  
□ White 24"  
24" Square x 21"H



### Cube Cocktail Tables

■ Black 24"  
□ White 24"  
24" Square x 16"H



### Hylton Tablet Table

White/Brushed Steel  
18"L x 12"D x 28"H

## OCCASIONAL TABLES



### Phoebe Tables

From left to right: Yellow, Lime Green, Rose, Gold, Teal  
17"Round x 22"H

## BARS & BAR BACKS



### Manhattan Bar

Black/Chrome  
63"L x 29"D x 42"H



### VIP Glow Bar 6'

Frosted Plexi with Built-in Wireless LED Kit  
72"L x 24"D x 42"H(Bar)  
13"D x 18"H (Shelf)  
\*Includes remote control



### VIP Glow Bar 4'

Frosted Plexi with Built-in Wireless LED Kit  
48"L x 24"D x 42"H(Bar)  
13"D x 18"H (Shelf)  
\*Includes remote control



### Bar

■ Black with 2 shelves in back  
□ White with 2 shelves in back  
48"L x 16"D x 42"H



### Blox Bar Back

Walnut/Brushed Metal  
30"L x 16"D x 86"H  
Please Inquire About Shelf Dimensions



### Piazza Bar Back

■ Black  
□ White  
44"L x 12"D x 80"H  
13"W x 14.25"H (Inside Shelf)

## BAR STOOLS



**Vienna Stool**  
 ■ Gray Acrylic  
 ■ Orange Acrylic  
 ■ Teal Acrylic  
 17"W x 17"D x 39"H



**Criss Cross Bar Stool**  
 ■ Espresso Leather  
 □ White Leather  
 15"W x 19"D x 41"H



**Escape Stool**  
 Natural Maple  
 16"Square x 41"H



**Silk Back Bar Stool**  
 ■ Black    ■ Green  
 □ White    ■ Purple  
 ■ Blue    ■ Red  
 17"L x 18"D x 42"H



**Euro Bar Stool**  
 Black  
 21"W x 23"D x 43"H



**Hourglass Bar Stool**  
 ■ Black  
 □ White  
 18"W x 20"D x 43"H



**Equino Stool**  
 ■ Black  
 □ White  
 15"W x 13"D x 35"H



## BAR STOOLS



**Caprice Stool**  
Black Fabric  
25"W x 26"D x 44"H



**Sonic Stool**  
Black  
22"W x 23"D x 42"H



**Marcus Bar Stool**  
18"W (at footbase) x 29"H



**Regal Stool**  
Brown Leather  
19"W x 24"D x 45"H

## CAFE CHAIRS



**Vienna Chair**  

- Gray Acrylic
- Orange Acrylic
- Teal Acrylic

 21"Square x 32"H



**Silk Back Chair**  

- Black
- Green
- White
- Purple
- Blue
- Red

 17"W x 18"D x 34"H  
 (Also Available With Arms)

## CAFE CHAIRS



**Escape Chair**  
Natural Maple  
17"W x 16"D x 32"H



**Leslie Chair**  
White  
17"W x 21"D x 31"H



**Criss Cross Chair**  
 Espresso Leather  
 White Leather  
 17"W x 21"D x 35"H



**Sonic Chair**  
Black  
20"W x 21"D x 32"H



**Elio Chair**  
17"Square x 33"H



**Caprice Chair**  
Black  
25"W x 24"D x 32"H



**Comet Chair**  
Black  
23"W x 22"D x 32"H (With Arms)  
19"W x 22"D x 32"H (Without Arms)



**Regal Dining Chair**  
Brown Leather  
19"W x 23"D x 38"H

## BAR TABLES



**Euro Bar Table**

Black/Black 30"  
30"Round x 42"H  
Black/Black 36"  
36"Round x 42"H



**Silk Bar Table**

Black/Chrome 30"  
30"Round x 42"H  
Black/Chrome 36"  
36"Round x 42"H



**Silk Bar Table  
Tulip Base**

Black/Chrome 30"  
30"Round x 42"H



**City Bar Table**

Maple/Black 30"  
30"Round x 42"H  
Maple/Black 36"  
36"Round x 42"H



**Park Ave Bar Table**

Maple/Chrome 30"  
30"Round x 42"H  
Maple/Chrome 36"  
36"Round x 42"H



**Park Ave Bar Table  
Tulip Base**

Maple/Chrome 30"  
30"Round x 42"H



**Summit Bar Table**

White/Black 30"  
30"Round x 42"H  
White/Black 36"  
36"Round x 42"H



**Blanco Round Bar Table**

White/Chrome 30"  
30"Round x 42"H  
White/Chrome 36"  
36"Round x 42"H



**Blanco Round Bar Table  
Tulip Base**

White/Chrome 30"  
30"Round x 42"H

## BAR TABLES



**Blanco Square Bar Table**

White/Chrome  
24"Square x 42"H



**Blanco Square Bar Table  
Tulip Base**

White/Chrome  
24"Square x 42"H



**Blanco Rectangle Bar Table**

White/Chrome  
72"L x 24"D x 42"H



**Spectrum Bar Table Red**

Red/Chrome  
24"Square x 42"H



**Spectrum Bar Table Red  
Tulip Base**

Red/Chrome  
24"Square x 42"H



**Spectrum Bar Table Green**

Green/Chrome  
24"Square x 42"H



**Spectrum Bar Table Green  
Tulip Base**

Green/Chrome  
24"Square x 42"H



**Spectrum Bar Table Blue**

Blue/Chrome  
24"Square x 42"H



**Spectrum Bar Table Blue  
Tulip Base**

Blue/Chrome  
24"Square x 42"H

## BAR TABLES



### Spectrum Bar Table Purple

Purple/Chrome  
24" Square x 42"H



### Spectrum Bar Table Purple Tulip Base

Purple/Chrome  
24" Square x 42"H

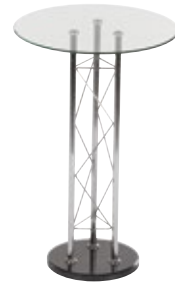

### Chardonnay Bar Table

Clear Glass/Chrome  
31" Round x 42"H



### Aspen Bar Table

White/Brushed Steel  
72"L x 26"D x 42"H

## CAFÉ TABLES



### Euro Café Table

Black/Black 30"  
30" Round x 30"H  
Black/Black 36"  
36" Round x 30"H



### Silk Café Table

Black/Chrome 30"  
30" Round x 30"H  
Black/Chrome 36"  
36" Round x 30"H



### Park Ave Café Table

Maple/Chrome 30"  
30" Round x 30"H  
Maple/Chrome 36"  
36" Round x 30"H



## CAFÉ TABLES

**City Café Table**

Maple/Black 30"  
30"Round x 30"H  
Maple/Black 36"  
36"Round x 30"H

**Summit Café Table**

White/Black 30"  
30"Round x 30"H  
White/Black 36"  
36"Round x 30"H

**Blanco Café Table**

White/Chrome 30"  
30"Round x 30"H  
White/Chrome 36"  
36"Round x 30"H

**Blanco Café Table**

White/Chrome Rectangle  
72"L x 24"D x 30"H

**White/Chrome Square**

24"Square x 30"H

**Spectrum Café Table Purple**

Purple/Chrome  
24"Square x 30"H

**Spectrum Café Table Red**

Red/Chrome  
24"Square x 30"H

**Spectrum Café Table Green**

Green/Chrome  
24"Square x 30"H

**Spectrum Café Table Blue**

Blue/Chrome  
24"Square x 30"H

**Aspen Dining Table**

White/Brushed Steel  
72"L x 30"D x 30"H

## OFFICE SEATING



**Tamiri High Back Chair**

Black Leather  
25"W x 27"D x 45"H



**Tamiri Mid Back Chair**

Black Leather  
25"W x 27"D x 29"H



**Tamiri Guest Chair**

Black Leather  
25"W x 27"D x 37"H



**Accord Chair**

■ Black  
□ White  
25"Square x 44"H



**Goal Task Chair**

Black  
25"Square x 39"H



**Goal Task Chair Armless**

Black  
21"W x 25"D x 39"H

## OFFICE SEATING



**Enterprise High Back Conference Chair**

Black Fabric  
25"W x 27"D x 45"H



**Enterprise Mid Back Conference Chair**

Black Fabric  
25"W x 27"D x 39"H



**Enterprise Guest Chair**

Black Fabric  
25"W x 27"D x 37"H



**Goal Drafting Stool**

Black  
25"W x 24"D x 48"H



**Goal Drafting Stool Armless**

Black  
21"W x 24"D x 48"H

## CONFERENCE TABLES



**Conference Table Round**

Black  
 Mahogany  
 42"Round x 29"H



**Conference Table Rectangle**

Black 6'  
 Mahogany 6'  
 Maple 6'  
 White 6'  
 72"L x 36"D x 30"H

Black 8'  
 Mahogany 8'  
 Maple 8'  
 White 8'  
 96"L x 48"D x 30"H

## OFFICE FURNITURE



**Computer Kiosk**

Black  
 White  
 24" Square x 42"H



**Computer Counter**

Graphite  
 48"L x 24"D x 42"H



**Computer Desk**

Graphite  
 48"L x 24"D x 29"H



**5 Shelf Bookcase**

Black  
 Mahogany  
 36"L x 12"D x 72"H



**Black Credenza**

Black  
 60"L x 20"D x 29"H



**Black Double Pedestal**

Black  
 60"L x 30"D x 29"H



**Genoa Storage Credenza**

Mahogany 2 Filing Cabinets  
 2-Drawers-Inside Shelves  
 66"L x 20"D x 29"H



**Genoa Kneespace Credenza**

Mahogany 2 Filing Cabinets/2-Drawers  
 66"L x 20"D x 29"H



**Genoa Executive Desk**

Mahogany Double Pedestal-Locking Drawers  
 72"L x 36"D x 29"H

## OFFICE FURNITURE



### Presidential Kneespace Credenza

Mahogany  
24"L x 66"L x 29"H



### Presidential Executive Desk

Mahogany  
36"L x 72"L x 29"H



### Presidential File Cabinet

Mahogany  
24"L x 36"L x 29"H



### Vivid Café Table Square

Clear Glass/Smoked Powder Coat Finish  
42" Square x 30"H



### Vivid Café Table Rectangle

Clear Glass/Smoked Powder Coat Finish  
60"L x 36"D x 30"H



### Brooklyn Rectangle Dining Table

Clear Glass/Chrome  
60"L x 36"D x 30"H



### Brooklyn Round Dining Table

Clear Glass/Chrome  
42" Round x 30"H



### Aspen Dining Table

White/Brushed Steel  
72"L x 30"D x 30"H



## METAL FILE & STORAGE CABINETS



### 2-Drawer File

Black Letter  
15"L x 25"D x 29"H  
Black Legal  
18"L x 25"D x 29"H



### 4-Drawer File

Black Letter  
15"L x 25"D x 52"H  
Black Legal  
18"L x 25"D x 52"H



### 2-Drawer Lateral File

Black (Pictured)  
36"L x 18"D x 27"H  
Black (Not Pictured)  
36"L x 20"D x 29"H



### 4-Drawer Lateral File

Black  
36"L x 18"D x 54"H



### Storage Cabinet

Black  
36"W x 18"D x 72"H

## PEDESTALS



### Display Pedestals 42"

- Black  
14"Square x 42"H
- Black  
24"Square x 42"H
- Black  
18"Square x 42"H
- White  
14"Square x 42"H



### Display Pedestals 36"

- Black  
14"Square x 36"H
- Black  
24"Square x 36"H
- White  
14"Square x 36"H
- White  
24"Square x 36"H



### Display Pedestals 30"

- Black  
14"Square x 30"H
- Black  
24"Square x 30"H
- Black  
18"Square x 30"H
- White  
14"Square x 30"H



### Locking Pedestal

- Black
  - White
- 24"Square x 42"H



### London Pedestal

- Chrome/Marble
- 24"Square x 42"H

## MISCELLANEOUS ITEMS



**Stanchion**  
Chrome  
41"H  
**Stanchion Rope**  
Red Velour  
6'L



**Literature Stand**  
■ Black  
■ Aluminum  
14.75"W x 12"D x 53.5"H



**Literature Rack**  
Black/Metal  
10.5"W x 9.5"D x 57"H



**Refrigerator Compact**  
White 4 Cu Ft  
19"W x 21"D x 33.5"H



**iPad® Stand**  
■ Black  
■ Silver  
14.25"W x 41.75"H  
(Fits 2nd, 3rd, or 4th iPad® generations. Can be positioned in portrait or landscape views.)

*\*Apple® and iPad® are registered trademarks of Apple Inc.*

## LIGHTING



### Brushed Steel Lamps

Table Lamp White/Steel  
26"H

Floor Lamp White/Steel  
66"H



### Brushed Nickel Lamps

Table Lamp White/Nickel  
29"H

Floor Lamp White/Nickel  
60"H



### Rubbed Bronze Lamps

Table Lamp White/Bronze  
28"H

Floor Lamp White/Bronze  
60"H



### Brushed Steel Lamps

Table Lamp Red/Steel  
26"H

Floor Lamp Red/Steel  
66"H



### Neutrino Floor Lamp

Steel  
67"H

# DESIGN YOUR BOOTH SPACE **YOUR WAY**



## **10x20 Booth Footprint**

Grammercy Loveseat & Corner • Novel Cocktail & End Table • 4FT VIP Bar • Criss Cross Chairs • Café Table



## **10x10 Booth Footprint**

Chamois Stage Chairs • Phoebe Table • Equino Stools  
Chardonnay Bar Table



## **10x10 Booth Footprint**

Metro Sofa & Chair • Novel End Tables  
Equino Stools • Silk Bar Table



## **20x20 Booth Footprint**

Whisper Sofa & Chairs • Brooklyn Cocktail & End Tables • Criss Cross Stools • Blanco Bar Table







# Speciality Furnishings Order Form

Email: [events@valleyexpodisplays.com](mailto:events@valleyexpodisplays.com)

Fax: 815-873-1544

## TRADE SHOW INFORMATION

Show Name		Booth #	
Company Name			
Onsite Contact Name			Onsite Contact Email
Company Address			Onsite Contact Cell #

\*\*\*All Furniture Subject to Availability\*\*\*

<b>Terms &amp; Conditions:</b>	<b>Payments:</b> Payment terms - 100% Payment due prior to delivery to secure the order.
<b>Cancellation Fee:</b>	If cancelled within 4 business days prior to delivery, a 100% charge will be applied.
<b>Show Site Orders:</b>	Show Site orders will be based on availability and charged a Late Fee. Please contact Valley Expo & Displays for late fee cost.
<b>Advance Pricing</b>	Payment and order form must be received by advanced date published on the General Show Information pages to receive advance pricing

Item Number	Weight		Dimensions	Advance	Floor	Qty.	Total
<b>Whisper (Pg. 3)</b>							
18228-0607	115 lbs.	Whisper White Leather Sofa	87"W x 37"D x 35"H	\$678.00	\$881.40		\$ -
18167-0471	90 lbs.	Whisper White Leather Loveseat	61"W x 37"D x 35"H	\$649.75	\$844.70		\$ -
18284-0487	60 lbs.	Whisper White Leather Chair	35"W x 37"D x 35"H	\$531.10	\$690.45		\$ -
18024-0003	43 lbs.	Whisper White Leather Bench Ottoman	60"W x 24"D x 17"H	\$293.80	\$381.95		\$ -
18184-0034	65 lbs.	Whisper White Leather Square Ottoman	40"Square x 17"H	\$293.80	\$381.95		\$ -
18184-0038	64 lbs.	Whisper White Leather Round Ottoman	46"Round x 17"H	\$293.80	\$381.85		\$ -
<b>Function (Pg. 3)</b>							
18284-0554	40 lbs.	Function White Leather Armless Chair	28"Square x 29"H	\$355.95	\$462.75		\$ -
18066-0016	36 lbs.	Function White Leather Corner	28"Square x 29"H	\$384.20	\$499.50		\$ -
<b>Continental (Pg. 4)</b>							
18303-0001	105 lbs.	Continental White Leather Curved Loveseat	82"W x 34"D x 31"H	\$700.60	\$910.80		\$ -
18304-0001	105 lbs.	Continental White Leather Reverse Loveseat	72"W x 34"D x 31"H	\$678.00	\$881.40		\$ -
18296-0005	35 lbs.	Continental White Leather Wedge Ottoman	30"W x 34"D x 19"H	\$293.80	\$381.95		\$ -
18184-0131	75 lbs.	Continental White Leather Curved Bench	70"W x 26"D x 19"H	\$350.30	\$455.40		\$ -
18184-0132	30 lbs.	Continental White Leather Half Moon Ottoman	33"W x 19"D x 19"H	\$293.80	\$381.85		\$ -
<b>Sophistication (Pg. 4 &amp; 5)</b>							
18228-0674	100 lbs.	Sophistication White Leather Sofa	72"W x 31"D x 48"H	\$700.60	\$910.80		\$ -
18167-0466	90 lbs.	Sophistication White Leather Loveseat	48"W x 31"D x 48"H	\$468.95	\$609.65		\$ -
18284-0563	60 lbs.	Sophistication White Leather Chair	27"W x 31"D x 48"H	\$350.30	\$455.40		\$ -
18066-0017	60 lbs.	Sophistication White Leather Corner	31"Square x 48"H	\$350.30	\$455.40		\$ -
18184-0130	40 lbs.	Sophistication White Leather Ottoman	31"Square x 19"H	\$265.55	\$345.25		\$ -
<b>Boca (Pg. 5)</b>							
18066-0026	38 lbs.	Boca Black Leather Corner	27"W x 27"D x 30"H	\$394.37	\$512.70		\$ -
18284-0786	28 lbs.	Boca Black Leather Armless	22"W x 27"D x 30"H	\$367.25	\$477.45		\$ -
<b>Metro (Pg. 5 &amp; 6)</b>							
18228-0602	110 lbs.	Metro Black Leather Sofa	85"W x 35"D x 35"H	\$581.95	\$756.55		\$ -
18167-0467	90 lbs.	Metro Black Leather Loveseat	60"W x 35"D x 35"H	\$553.70	\$719.85		\$ -
18284-0482	75 lbs.	Metro Black Leather Chair	35"Square x 35"H	\$435.05	\$565.60		\$ -
18184-0179	65 lbs.	Metro Black Leather Square Ottoman	40"Square x 17"H	\$293.80	\$381.95		\$ -
18024-0008	43 lbs.	Metro Black Leather Bench Ottoman	60"W x 24"D x 17"H	\$293.80	\$381.95		\$ -
<b>Suave Midnight (Pg. 6)</b>							
18228-0085	105 lbs.	Suave Midnight Sofa	77"W x 36"D x 33"H	\$502.85	\$653.75		\$ -
18167-0069	80 lbs.	Suave Midnight Loveseat	54"W x 36"D x 33"H	\$440.70	\$572.95		\$ -
18284-0151	65 lbs.	Suave Midnight Chair	32"W x 36"D x 33"H	\$327.70	\$426.05		\$ -
<b>Grammercy (Pg. 6)</b>							
18228-0605	90 lbs.	Grammercy Charcoal Leather Sofa	82"W x 36"D x 36"H	\$649.75	\$1,121.25		\$ -
18167-0469	90 lbs.	Grammercy Charcoal Leather Loveseat	57"W x 36"D x 36"H	\$559.35	\$965.25		\$ -
18284-0485	40 lbs.	Grammercy Charcoal Leather Chair	28"W x 36"D x 36"H	\$355.95	\$614.25		\$ -
18066-0015	51 lbs.	Grammercy Charcoal Leather Corner	36"Square x 36"H	\$547.50	\$711.75		\$ -
<b>Parma (Pg. 7)</b>							
18228-0789	100 lbs.	Parma Brown Leather Sofa	79"W x 37"D x 36"H	\$581.95	\$756.55		\$ -
18167-0577	90 lbs.	Parma Brown Leather Loveseat	56"W x 37"D x 36"H	\$553.70	\$719.85		\$ -
18284-0710	75 lbs.	Parma Brown Leather Chair	33"W x 37"D x 36"H	\$435.05	\$565.60		\$ -
18024-0061	43 lbs.	Parma Brown Leather Bench Ottoman	60"W x 24"D x 17"H	\$293.80	\$381.95		\$ -
<b>Montana Mocha (Pg. 7)</b>							
18228-0784	100 lbs.	Montana Mocha Sofa	79"W x 35"D x 34"H	\$542.40	\$936.00		\$ -
18167-0573	90 lbs.	Montana Mocha Loveseat	57"W x 35"D x 34"H	\$474.60	\$819.00		\$ -
18284-0704	75 lbs.	Montana Mocha Chair	35"Square x 34"H	\$367.25	\$633.75		\$ -
<b>Chandler (Pg. 8)</b>							
18228-0795	100 lbs.	Chandler Red Leather Sofa	76"W x 37"D x 35"H	\$581.95	\$756.55		\$ -
18167-0581	90 lbs.	Chandler Red Leather Loveseat	53"W x 37"D x 35"H	\$553.70	\$719.85		\$ -
18284-0717	75 lbs.	Chandler Red Leather Chair	31"W x 37"D x 35"H	\$435.05	\$565.60		\$ -
18024-0062	43 lbs.	Chandler Red Leather Bench Ottoman	60"W x 24"D x 17"H	\$293.80	\$381.95		\$ -
<b>Evoke (Pg. 8 &amp; 9)</b>							
13229-0007	80 lbs.	Evoke Sofa	81"W x 35"D x 27"H	\$881.40	\$1,145.85		\$ -
13041-0015	40 lbs.	Evoke Chair	33"W x 35"D x 27"H	\$468.95	\$609.65		\$ -
13054-0011	20 lbs.	Evoke Cocktail Table	48"W x 24"D x 18"H	\$293.80	\$381.95		\$ -

13110-0009	20 lbs.	Evoke End Table	24"W x 28"D x 25"H	\$265.55	\$345.25	\$	-
13110-0008	10 lbs.	Evoke Cube	18"Square	\$180.80	\$235.05	\$	-
<b>Stage Chairs (Pg. 9 &amp; 10)</b>							
18284-0478	29 lbs.	Midnight Microfiber Stage Chair	25"W x 26"D x 37"H	\$209.05	\$271.80	\$	-
18284-0477	29 lbs.	Chamois Microfiber Stage Chair	25"W x 26"D x 37"H	\$209.05	\$271.80	\$	-
18284-0476	29 lbs.	Buckskin Microfiber Stage Chair	25"W x 26"D x 37"H	\$209.05	\$271.80	\$	-
18284-0621	80 lbs.	Empire Chair Black Leather	28"W x 32"D x 32"H	\$384.20	\$499.50	\$	-
18284-0564	80 lbs.	Empire Chair White Leather	28"W x 32"D x 32"H	\$384.20	\$499.50	\$	-
18284-0590	50 lbs.	Ibizia Black Leather Chair	31"W x 35"D x 32"H	\$531.10	\$690.45	\$	-
18284-0449	50 lbs.	Ibizia White Leather Chair	31"W x 35"D x 32"H	\$531.10	\$690.45	\$	-
05035-0028	65 lbs.	Tulip Black Fabric Chair	26"W x 27"D x 35"H	\$231.65	\$301.15	\$	-
18284-0785	24 lbs.	Monarch Chair - Bright White	28"Square x 30"H	\$440.70	\$572.95	\$	-
<b>Ottomans &amp; Benches (Pg. 10)</b>							
18184-0131	75 lbs.	Continental White Leather Curved Bench	70"W x 26"D x 19"H	\$350.30	\$455.40	\$	-
18184-0179	65 lbs.	Metro Black Leather Square Ottoman	40"Square x 17"H	\$293.80	\$381.95	\$	-
18184-0034	65 lbs.	Whisper White Leather Square Ottoman	40"Square x 17"H	\$293.80	\$381.95	\$	-
18184-0033	65 lbs.	Grammercy Charcoal Leather Square Ottoman	40"Square x 17"H	\$293.80	\$381.95	\$	-
18024-0008	43 lbs.	Metro Black Leather Bench Ottoman	60"W x 24"D x 17"H	\$293.80	\$381.95	\$	-
18024-0003	43 lbs.	Whisper White Leather Bench Ottoman	60"W x 24"D x 17"H	\$293.80	\$381.95	\$	-
18024-0062	43 lbs.	Chandler Red Leather Bench Ottoman	60"W x 24"D x 17"H	\$293.80	\$381.95	\$	-
18024-0002	43 lbs.	Grammercy Charcoal Leather Bench Ottoman	60"W x 24"D x 17"H	\$293.80	\$381.95	\$	-
18024-0061	43 lbs.	Parma Brown Leather Bench Ottoman	60"W x 24"D x 17"H	\$293.80	\$381.95	\$	-
18184-0192	70 lbs.	Essentials White Leather Storage Ottoman	48"W x 24"D x 20"H	\$412.45	\$536.20	\$	-
18184-0036	64 lbs.	Grammercy Charcoal Leather Round Ottoman	46"Round x 17"H	\$293.80	\$381.95	\$	-
18184-0038	64 lbs.	Whisper White Leather Round Ottoman	46"Round x 17"H	\$293.80	\$381.95	\$	-
18184-0028	15 lbs.	Grammercy Charcoal 1/4 Round Ottoman	34"W x 19"D x 17"H	\$175.15	\$227.70	\$	-
18184-0030	15 lbs.	Whisper White 1/4 Round Ottoman	34"W x 19"D x 17"H	\$175.15	\$227.70	\$	-
<b>Banquettes &amp; Turning Beds (Pg. 11)</b>							
18011-0011	185 lbs.	Essentials White Banquette (2 pcs)	60"Round x 48"H	\$881.40	\$1,145.85	\$	-
18011-0001	130 lbs.	Whisper White Tufted Leather Banquette (2 pcs)	59"Round x 38"H	\$881.40	\$1,145.85	\$	-
18011-0002	130 lbs.	Grammercy Charcoal Leather Banquette (2 pcs)	59"Round x 38"H	\$881.40	\$1,145.85	\$	-
02082-0033	200 lbs.	Essentials White Leather Turning Bed	96"W x 48"D x 34"H	\$935.00	\$1,215.50	\$	-
<b>Cube Ottomans (Pg. 11 &amp; 12)</b>							
18184-0198	15 lbs.	Regency Orange Cube	18"Square	\$113.00	\$146.90	\$	-
18184-0196	15 lbs.	Regency Teal Cube	18"Square	\$113.00	\$146.90	\$	-
18184-0197	15 lbs.	Regency Ruby Cube	18"Square	\$113.00	\$146.90	\$	-
18184-0200	15 lbs.	Regency Camel Cube	18"Square	\$113.00	\$146.90	\$	-
18184-0193	15 lbs.	Regency Apple Cube	18"Square	\$113.00	\$146.90	\$	-
18184-0199	15 lbs.	Regency Fuchsia Cube	18"Square	\$113.00	\$146.90	\$	-
18184-0129	15 lbs.	Cube Ottoman - White	18"Square	\$113.00	\$146.90	\$	-
18184-0128	15 lbs.	Cube Ottoman - Black	18"Square	\$113.00	\$146.90	\$	-
18200-0001	15 lbs.	Cube Ottoman - Red	18"Square	\$113.00	\$146.90	\$	-
18200-0002	15 lbs.	Cube Ottoman - Green	18"Square	\$113.00	\$146.90	\$	-
18200-0003	15 lbs.	Cube Ottoman - Blue	18"Square	\$113.00	\$146.90	\$	-
18200-0004	15 lbs.	Cube Ottoman - Purple	18"Square	\$113.00	\$146.90	\$	-
<b>Charged (Pg. 12)</b>							
22100-0001	192 lbs.	Essentials Turning Bed w/Charging Station Insert	96"W x 48"D x 19"H	\$1,175.20	\$1,527.80	\$	-
22051-0001	40 lbs.	Boca Bright White Corner - Charged	27"W x 27"D x 30"H	\$440.70	\$572.95	\$	-
22050-0001	40 lbs.	Boca Bright White Armless - Charged	22"W x 27"D x 30"H	\$406.80	\$528.85	\$	-
22001-0001	80 lbs.	Aspen Bar Table - Charged	72"W x 26"D x 42"H	\$689.30	\$896.10	\$	-
22002-0002	55 lbs.	Aspen Cocktail Table - Charged	48"W x 24"D x 18"H	\$384.20	\$499.50	\$	-
22200-0001	230 lbs.	White Conference Table - Charged	96"W x 43"D x 30"H	\$926.60	\$1,204.60	\$	-
<b>Occasional Tables (Pg. 13, 14, &amp; 15)</b>							
12107-0008	30 lbs.	Tribeca End Table	24"W x 28"D x 22"H	\$203.40	\$264.45	\$	-
12230-0005	40 lbs.	Tribeca Sofa/Console Table	48"W x 18"D x 30"H	\$214.70	\$279.15	\$	-
12055-0008	50 lbs.	Tribeca Cocktail Table	48"W x 28"D x 19"H	\$226.00	\$293.80	\$	-
12107-0281	30 lbs.	Harmony End Table	24"Round x 22"H	\$203.40	\$264.45	\$	-
12230-0080	55 lbs.	Harmony Sofa/Console Table	52"W x 18"D x 30"H	\$226.00	\$293.80	\$	-
12055-0272	60 lbs.	Harmony Cocktail Table	51"W x 28"D x 18"H	\$217.70	\$283.05	\$	-
18024-0010	30 lbs.	Novel End Table	15"Square x 16"H	\$265.55	\$345.25	\$	-
18024-0011	50 lbs.	Novel Cocktail Table	46"W x 15"D x 16"H	\$293.80	\$381.95	\$	-
99-12304-05	10 lbs.	Aria Red End Table	24"W x 20"D x 22"H	\$203.40	\$264.45	\$	-
99-12050-05	20 lbs.	Aria Red Cocktail Table	44"W x 20"D x 18"H	\$214.70	\$279.15	\$	-
99-12304-03	10 lbs.	Aria Green End Table	24"W x 20"D x 22"H	\$203.40	\$264.45	\$	-
99-12050-03	20 lbs.	Aria Green Cocktail Table	44"W x 20"D x 18"H	\$214.70	\$279.15	\$	-
99-12304-06	10 lbs.	Aria Blue End Table	24"W x 20"D x 22"H	\$203.40	\$264.45	\$	-
99-12050-06	20 lbs.	Aria Blue Cocktail Table	44"W x 20"D x 18"H	\$214.70	\$279.15	\$	-
99-12304-04	10 lbs.	Aria Purple End Table	24"W x 20"D x 22"H	\$203.40	\$264.45	\$	-
99-12050-04	20 lbs.	Aria Purple Cocktail Table	44"W x 20"D x 18"H	\$214.70	\$279.15	\$	-
99-12304-01	10 lbs.	Aria White End Table	24"W x 20"D x 22"H	\$203.40	\$264.45	\$	-
99-12305-01	35 lbs.	Aria White Sofa/Console Table	44"W x 20"D x 30"H	\$226.00	\$293.80	\$	-
99-12050-01	20 lbs.	Aria White Cocktail Table	44"W x 20"D x 18"H	\$214.70	\$279.15	\$	-
99-12304-02	10 lbs.	Aria Charcoal End Table	24"W x 20"D x 22"H	\$203.40	\$264.45	\$	-
99-12305-02	35 lbs.	Aria Charcoal Sofa/Console Table	44"W x 20"D x 30"H	\$226.00	\$293.80	\$	-
99-12050-02	20 lbs.	Aria Charcoal Cocktail Table	44"W x 20"D x 18"H	\$214.70	\$279.15	\$	-
12107-0493	27 lbs.	London End Table	24"Square x 23"H	\$292.50	\$380.25	\$	-
12230-0110	49 lbs.	London Sofa/Console Table	60"W x 16"D x 34"H	\$367.50	\$477.75	\$	-
12055-0428	55 lbs.	London Cocktail Table	40"Square x 16"H	\$337.50	\$438.75	\$	-

12107-0494	21 lbs.	Brooklyn II Square End Table	22"W X 22"D X 20"H	\$247.50	\$321.75	\$	-
12107-0495	15 lbs.	Brooklyn II Round End Table	20"Round X 20"H	\$247.50	\$321.75	\$	-
12055-0429	35 lbs.	Brooklyn II Rect Cocktail Table	42"W X 24"D X 16"H	\$277.50	\$360.75	\$	-
12055-0430	25 lbs.	Brooklyn II Round Cocktail Table	30"Round X 16"H	\$277.50	\$360.75	\$	-
12107-0282	35 lbs.	Vivid End Table	26"Square x 21"H	\$203.40	\$264.45	\$	-
12230-0081	62 lbs.	Vivid Sofa/Console Table	50"W x 24"D x 30"H	\$226.00	\$293.80	\$	-
12055-0273	50 lbs.	Vivid Cocktail Table	50"W x 24"D x 16"H	\$214.70	\$279.15	\$	-
12107-0331	35 lbs.	Club End Table w/ Built-in LED Lighting	22"Square x 18"H	\$265.55	\$345.25	\$	-
12055-0318	55 lbs.	Club Cocktail Table w/ Built-in LED Lighting	44"W x 22"D x 18"H	\$293.80	\$381.95	\$	-
12003-0038	15 lbs.	Rose Table	17"Round x 17"H	\$231.65	\$301.15	\$	-
12003-0039	20 lbs.	Zanzibar Table	17"Square	\$231.65	\$301.15	\$	-
12107-0296	50 lbs.	Cube, Black 24" End Table	24"Square x 21"H	\$209.05	\$271.80	\$	-
12107-0297	55 lbs.	Cube, White 24" End Table	24"Square x 21"H	\$209.05	\$271.80	\$	-
12055-0285	40 lbs.	Cube, Black 24" Cocktail Table	24"Square x 16"H	\$203.40	\$264.45	\$	-
12055-0286	40 lbs.	Cube, White 24" Cocktail Table	24"Square x 16"H	\$203.40	\$264.45	\$	-
12107-0467	13 lbs.	Hylton Table	18"W x 12"D x 28"H	\$180.80	\$235.05	\$	-
12003-0056	11 lbs.	Phoebe Table - Yellow	17"Round x 22"H	\$135.60	\$176.30	\$	-
12003-0052	11 lbs.	Phoebe Table - Lime Green	17"Round x 22"H	\$135.60	\$176.30	\$	-
12003-0053	11 lbs.	Phoebe Table - Rose	17"Round x 22"H	\$135.60	\$176.30	\$	-
12003-0051	11 lbs.	Phoebe Table - Gold	17"Round x 22"H	\$135.60	\$176.30	\$	-
12003-0074	11 lbs.	Phoebe Table - Teal	17"Round x 22"H	\$135.60	\$176.30	\$	-
<b>Bars &amp; Bar Backs (Pg. 15)</b>							
05012-0001	156 lbs.	Manhattan Martini Bar	63"W x 29"D x 42"H	\$768.40	\$998.95	\$	-
05012-0026	185 lbs.	VIP Frosted Plexi Glow Bar 6'	72"W x 24"D x 42"H	\$768.40	\$998.95	\$	-
05012-0024	130 lbs.	VIP Frosted Plexi Glow Bar 4'	48"W x 24"D x 42"H	\$649.75	\$844.70	\$	-
05012-0053	70 lbs.	Black Bar - 2 Shelf	48"W x 16"D x 42"H	\$350.30	\$455.40	\$	-
05012-0054	70 lbs.	White Bar - 2 Shelf	48"W x 16"D x 42"H	\$350.30	\$455.40	\$	-
12112-0010	60 lbs.	Blox Bar Back	30"W x 16"D x 86"H	\$440.70	\$572.95	\$	-
05001-0017	150 lbs.	Piazza Bar Back - Black	44"W x 12"D x 80"H	\$412.45	\$536.20	\$	-
05001-0018	150 lbs.	Piazza Bar Back - White	44"W x 12"D x 80"H	\$412.45	\$536.20	\$	-
<b>Bar Stools (Pg. 16 &amp; 17)</b>							
05237-0264	15 lbs.	Vienna Stool - Gray	17"Square x 39"H	\$214.70	\$279.15	\$	-
05237-0263	15 lbs.	Vienna Stool - Orange	17"Square x 39"H	\$214.70	\$279.15	\$	-
05237-0262	15 lbs.	Vienna Stool - Teal	17"Square x 39"H	\$214.70	\$279.15	\$	-
05237-0038	15 lbs.	Criss Cross Bar Stool - Espresso	15"W x 19"D x 41"H	\$192.10	\$249.75	\$	-
05237-0039	15 lbs.	Criss Cross Bar Stool - White	15"W x 19"D x 41"H	\$192.10	\$249.75	\$	-
05237-0036	15 lbs.	Escape Bar Stool - Natural Maple	16"Square x 41"H	\$163.85	\$213.05	\$	-
99-05237-01	20 lbs.	Silk Back Bar Stool - Black	17"W x 18"D x 42"H	\$180.80	\$235.05	\$	-
99-05237-02	20 lbs.	Silk Back Bar Stool - White	17"W x 18"D x 42"H	\$180.80	\$235.05	\$	-
99-05237-06	20 lbs.	Silk Back Bar Stool - Blue	17"W x 18"D x 42"H	\$180.80	\$235.05	\$	-
99-05237-03	20 lbs.	Silk Back Bar Stool - Green	17"W x 18"D x 42"H	\$180.80	\$235.05	\$	-
99-05237-04	20 lbs.	Silk Back Bar Stool - Purple	17"W x 18"D x 42"H	\$180.80	\$235.05	\$	-
99-05237-05	20 lbs.	Silk Back Bar Stool - Red	17"W x 18"D x 42"H	\$180.80	\$235.05	\$	-
05237-0221	20 lbs.	Euro Bar Stool - Black	22"W x 24"D x 42"H	\$180.80	\$235.05	\$	-
05237-0230	40 lbs.	Hourglass Bar Stool - Black	18"W x 20"D x 43"H	\$197.75	\$257.10	\$	-
05237-0231	40 lbs.	Hourglass Bar Stool - White	18"W x 20"D x 43"H	\$197.75	\$257.10	\$	-
05237-0160	35 lbs.	Equino Bar Stool - Black	15"W x 13"D x 35"H	\$197.75	\$257.10	\$	-
05237-0041	35 lbs.	Equino Bar Stool - White	15"W x 13"D x 35"H	\$197.75	\$257.10	\$	-
05237-0169	25 lbs.	Caprice Bar Stool - Black	25"W x 26"D x 44"H	\$197.75	\$257.10	\$	-
05237-0042	15 lbs.	Sonic Bar Stool - Black	22"W x 23"D x 42"H	\$163.85	\$213.05	\$	-
05237-0215	15 lbs.	Marcus Bar Stool - Gunmetal	18"Square x 29"H	\$146.90	\$191.00	\$	-
05237-0156	20 lbs.	Regal Stool - Brown Leather	19"W x 24"D x 45"H	\$197.75	\$257.10	\$	-
<b>Café Chairs (Pg. 17 &amp; 18)</b>							
05035-0032	15 lbs.	Vienna Chair - Gray	21"Square x 32"H	\$135.60	\$176.30	\$	-
05035-0031	15 lbs.	Vienna Chair - Orange	21"Square x 32"H	\$135.60	\$176.30	\$	-
05035-0030	15 lbs.	Vienna Chair - Teal	21"Square x 32"H	\$135.60	\$176.30	\$	-
99-05035-10	20 lbs.	Silk Back Armless Chair - Black	17"W x 18"D x 34"H	\$113.00	\$146.90	\$	-
99-05035-11	20 lbs.	Silk Back Armless Chair - White	17"W x 18"D x 34"H	\$113.00	\$146.90	\$	-
99-05035-15	20 lbs.	Silk Back Armless Chair - Blue	17"W x 18"D x 34"H	\$113.00	\$146.90	\$	-
99-05035-12	20 lbs.	Silk Back Armless Chair - Green	17"W x 18"D x 34"H	\$113.00	\$146.90	\$	-
99-05035-13	20 lbs.	Silk Back Armless Chair - Purple	17"W x 18"D x 34"H	\$113.00	\$146.90	\$	-
99-05035-14	20 lbs.	Silk Back Armless Chair - Red	17"W x 18"D x 34"H	\$113.00	\$146.90	\$	-
05035-0009	10 lbs.	Escape Chair - Natural Maple	17"W x 16"D x 32"H	\$113.00	\$146.90	\$	-
05035-0008	10 lbs.	Leslie Chair - White	17"W x 21"D x 31"H	\$101.70	\$132.25	\$	-
05035-0010	15 lbs.	Criss Cross Chair - Espresso	17"W x 21"D x 35"H	\$129.95	\$168.95	\$	-
05035-0011	15 lbs.	Criss Cross Chair - White	17"W x 21"D x 35"H	\$129.95	\$168.95	\$	-
14233-0016	10 lbs.	Sonic Chair - Black	20"W x 21"D x 32"H	\$113.00	\$146.90	\$	-
05035-0023	24 lbs.	Elio Chair	17"Square x 33"H	\$113.00	\$146.90	\$	-
14233-0025	20 lbs.	Caprice Chair - Black	25"W x 24"D x 32"H	\$113.00	\$146.90	\$	-
14233-0005	20 lbs.	Comet Stack Arm Chair - Black	23"W x 22"D x 32"H	\$158.20	\$205.70	\$	-
14233-0006	15 lbs.	Comet Stack Armless Chair - Black	19"W x 22"D x 32"H	\$146.90	\$191.00	\$	-
05221-0039	20 lbs.	Regal Dining Chair - Brown	19"W x 23"D x 38"H	\$163.85	\$213.05	\$	-
<b>Bar Tables (Pg. 19, 20, &amp; 21)</b>							
99-05245-01	34 lbs.	Euro Bar Table Black/Black 30" Round	30"Round x 42"H	\$203.40	\$264.45	\$	-
99-05245-02	41 lbs.	Euro Bar Table Black/Black 36" Round	36"Round x 42"H	\$209.05	\$271.80	\$	-
99-05245-04	30 lbs.	Silk Bar Table Black/Chrome 30" Round	30"Round x 42"H	\$203.40	\$264.45	\$	-
99-05245-05	37 lbs.	Silk Bar Table Black/Chrome 36" Round	36"Round x 42"H	\$209.05	\$271.80	\$	-
99-05245-04 Tulip	41 lbs.	Silk Bar Table Black/Tulip Base 30" Round	30"Round x 42"H	\$322.50	\$419.25	\$	-



99-05245-14	34 lbs.	City Bar Table Maple/Black 30" Round	30"Round x 42"H	\$203.40	\$264.45	\$	-
99-05245-15	41 lbs.	City Bar Table Maple/Black 36" Round	36"Round x 42"H	\$209.05	\$271.80	\$	-
99-05245-07	30 lbs.	Park Ave Bar Table Maple/Chrome 30" Round	30"Round x 42"H	\$203.40	\$264.45	\$	-
99-05245-08	37 lbs.	Park Ave Bar Table Maple/Chrome 36" Round	36"Round x 42"H	\$209.05	\$271.80	\$	-
99-05245-07 Tulip	41 lbs.	Park Ave Bar Table Maple/Tulip Base 30" Round	30"Round x 42"H	\$322.50	\$419.25	\$	-
99-05245-16	34 lbs.	Summit Bar Table White/Black 30" Round	30"Round x 42"H	\$203.40	\$264.45	\$	-
99-05245-17	41 lbs.	Summit Bar Table White/Black 36" Round	36"Round x 42"H	\$209.05	\$271.80	\$	-
99-05245-10	30 lbs.	Blanco Bar Table White/Chrome 30" Round	30"Round x 42"H	\$203.40	\$264.45	\$	-
99-05245-11	37 lbs.	Blanco Bar Table White/Chrome 36" Round	36"Round x 42"H	\$209.05	\$271.80	\$	-
99-05245-10 Tulip	41 lbs.	Blanco Bar Table White/Tulip Base 30" Round	30"Round x 42"H	\$322.50	\$419.25	\$	-
99-05245-12	28 lbs.	Blanco Bar Table - White/Chrome 24"Square	24"Square x 42"H	\$203.40	\$264.45	\$	-
99-05245-12 Tulip	39 lbs.	Blanco Bar Table - White/Tulip Base 24"Square	24"Square x 42"H	\$322.50	\$419.25	\$	-
99-05245-13	69 lbs.	Blanco Rectangle Bar Table - White/Chrome	72"W x 24"D x 42"H	\$322.05	\$418.70	\$	-
99-05245-20	28 lbs.	Spectrum Bar Table Red	24"Square x 42"H	\$226.00	\$293.80	\$	-
99-05245-20 Tulip	39 lbs.	Spectrum Bar Table Red Tulip Base	24"Square x 42"H	\$360.00	\$468.00	\$	-
99-05245-19	28 lbs.	Spectrum Bar Table Green	24"Square x 42"H	\$226.00	\$293.80	\$	-
99-05245-19 Tulip	39 lbs.	Spectrum Bar Table Green Tulip Base	24"Square x 42"H	\$360.00	\$468.00	\$	-
99-05245-21	28 lbs.	Spectrum Bar Table Blue	24"Square x 42"H	\$226.00	\$293.80	\$	-
99-05245-21 Tulip	39 lbs.	Spectrum Bar Table Blue Tulip Base	24"Square x 42"H	\$360.00	\$468.00	\$	-
99-05245-18	28 lbs.	Spectrum Bar Table Purple	24"Square x 42"H	\$226.00	\$293.80	\$	-
99-05245-18 Tulip	39 lbs.	Spectrum Bar Table Purple Tulip Base	24"Square x 42"H	\$360.00	\$468.00	\$	-
05012-0002	35 lbs.	Chardonnay Glass & Chrome Bar Table	31"Round x 42"H	\$293.80	\$381.95	\$	-
05204-0001	75 lbs.	Aspen Bar Table	72"W x 26"D x 42"H	\$587.60	\$763.90	\$	-
<b>Café Tables (Pg. 21 &amp; 22)</b>							
99-05036-01	30 lbs.	Euro Café Table Black/Black 30" Round	30"Round x 29"H	\$203.40	\$264.45	\$	-
99-05036-02	37 lbs.	Euro Café Table Black/Black 36" Round	36"Round x 29"H	\$209.05	\$271.80	\$	-
99-05036-04	27 lbs.	Silk Café Table Black/Chrome 30" Round	30"Round x 29"H	\$203.40	\$264.45	\$	-
99-05036-05	34 lbs.	Silk Café Table Black/Chrome 36" Round	36"Round x 29"H	\$209.05	\$271.80	\$	-
99-05036-07	27 lbs.	Park Ave Café Table Maple/Chrome 30" Round	30"Round x 29"H	\$203.40	\$264.45	\$	-
99-05036-08	34 lbs.	Park Ave Café Table Maple/Chrome 36" Round	36"Round x 29"H	\$209.05	\$271.80	\$	-
99-05036-14	30 lbs.	City Café Table Maple/Black 30" Round	30"Round x 29"H	\$203.40	\$264.45	\$	-
99-05036-15	37 lbs.	City Café Table Maple/Black 36" Round	36"Round x 29"H	\$209.05	\$271.80	\$	-
99-05036-16	30 lbs.	Summit Café Table White/Black 30" Round	30"Round x 29"H	\$203.40	\$264.45	\$	-
99-05036-17	37 lbs.	Summit Café Table White/Black 36" Round	36"Round x 29"H	\$209.05	\$271.80	\$	-
99-05036-10	27 lbs.	Blanco Café Table White/Chrome 30" Round	30"Round x 29"H	\$203.40	\$264.45	\$	-
99-05036-11	34 lbs.	Blanco Café Table White/Chrome 36" Round	36"Round x 29"H	\$209.05	\$271.80	\$	-
99-05036-13	63 lbs.	Blanco Café Table White/Chrome Rectangle	72"W x 24"D x 29"H	\$322.05	\$418.70	\$	-
99-05036-12	25 lbs.	Blanco Café Table White/Chrome 24"Square	24"Square x 30"H	\$203.40	\$264.45	\$	-
99-05036-18	25 lbs.	Spectrum Café Table Purple	24"Square x 29"H	\$220.35	\$286.50	\$	-
99-05036-20	25 lbs.	Spectrum Café Table Red	24"Square x 29"H	\$220.35	\$286.50	\$	-
99-05036-19	25 lbs.	Spectrum Café Table Green	24"Square x 29"H	\$220.35	\$286.50	\$	-
99-05036-21	25 lbs.	Spectrum Café Table Blue	24"Square x 29"H	\$220.35	\$286.50	\$	-
05090-0001	90 lbs.	Aspen Dining Table	72"W x 30"D x 30"H	\$497.20	\$646.40	\$	-
<b>Office Seating (Pg. 23 &amp; 24)</b>							
14136-0002	38 lbs.	Tamiri Black Leather High Back Chair	25"W x 27"D x 45"H	\$265.55	\$345.25	\$	-
14176-0007	37 lbs.	Tamiri Black Leather Mid Back Chair	27"Square x 39"H	\$226.00	\$293.80	\$	-
14128-0002	41 lbs.	Tamiri Black Leather Guest Chair	25"W x 26"D x 37"H	\$209.05	\$271.80	\$	-
14136-0081	40 lbs.	Accord Black Leather High Back	25"Square x 44"H	\$327.70	\$426.05	\$	-
14136-0010	40 lbs.	Accord White Leather High Back	25"Square x 44"H	\$327.70	\$426.05	\$	-
14250-0013	36 lbs.	Goal Black Task Chair With Arms	25"Square x 39"H	\$169.50	\$220.35	\$	-
14250-0014	38 lbs.	Goal Black Task Chair Armless	21"W x 25"D x 39"H	\$158.20	\$205.70	\$	-
14136-0080	40 lbs.	Enterprise High Back Black Fabric Conference Chair	25"W x 27"D x 45"H	\$231.65	\$301.15	\$	-
14176-0046	35 lbs.	Enterprise Mid Back Black Fabric Conference Chair	24"W x 26"D x 39"H	\$209.05	\$271.80	\$	-
14128-0096	30 lbs.	Enterprise Guest Black Fabric Conference Chair	25"W x 27"D x 37"H	\$192.10	\$249.75	\$	-
14307-0003	36 lbs.	Goal Black Drafting Stool - Arms	25"W x 24"D x 48"H	\$180.80	\$235.05	\$	-
14307-0004	30 lbs.	Goal Black Drafting Stool - Armless	21"W x 24"D x 48"H	\$169.50	\$220.35	\$	-
<b>Conference Tables (Pg. 24)</b>							
14062-0105	97 lbs.	42" Round Conference Table - Black	42" Round x 29"H	\$382.50	\$497.25	\$	-
14062-0106	97 lbs.	42" Round Conference Table - Mahogany	42" Round x 29"H	\$382.50	\$497.25	\$	-
14062-0224	175 lbs.	Conference Rectangle Table 6' - Black	72"W x 36"D x 30"H	\$491.55	\$639.05	\$	-
14062-0220	175 lbs.	Conference Rectangle Table 6' - Mahogany	72"W x 36"D x 30"H	\$491.55	\$639.05	\$	-
14062-0256	175 lbs.	Conference Rectangle Table 6' - Maple	72"W x 36"D x 30"H	\$491.55	\$639.05	\$	-
14062-0281	175 lbs.	Conference Rectangle Table 6' - White	72"W x 36"D x 30"H	\$519.80	\$675.75	\$	-
14062-0225	220 lbs.	Conference Rectangle Table 8' - Black	96"W x 48"D x 30"H	\$531.10	\$690.45	\$	-
14062-0226	220 lbs.	Conference Rectangle Table 8' - Mahogany	96"W x 48"D x 30"H	\$531.10	\$690.45	\$	-
14062-0257	220 lbs.	Conference Rectangle Table 8' - Maple	96"W x 48"D x 30"H	\$531.10	\$690.45	\$	-
14062-0282	220 lbs.	Conference Rectangle Table 8' - White	96"W x 48"D x 30"H	\$531.10	\$690.45	\$	-
<b>Office Furniture (Pg. 25 &amp; 26)</b>							
14309-0001	125 lbs.	Computer Kiosk - Black	24"Square x 42"H	\$429.40	\$558.25	\$	-
14179-0005	125 lbs.	Computer Kiosk - White	24"Square x 42"H	\$429.40	\$558.25	\$	-
14061-0002	20 lbs.	Computer Counter - Graphite	48"W x 24"D x 42"H	\$209.05	\$272.45	\$	-
14076-0014	20 lbs.	Computer Desk - Graphite	48"W x 24"D x 29"H	\$197.75	\$257.10	\$	-
14029-0098	56 lbs.	5 Shelf Bookcase - Black	36"W x 12"D x 72"H	\$412.45	\$536.20	\$	-
14029-0096	55 lbs.	5 Shelf Bookcase - Mahogany	36"W x 12"D x 72"H	\$412.45	\$526.20	\$	-
14072-0108	225 lbs.	Black Credenza	60"W x 20"D x 29"H	\$384.20	\$499.50	\$	-
14083-0105	290 lbs.	Black Double Pedestal Desk	60"W x 30"D x 29"H	\$440.70	\$572.95	\$	-
14072-0038	225 lbs.	Genoa Storage Credenza - Mahogany - 2 Drawer	66"W x 20"D x 29"H	\$384.20	\$499.50	\$	-
14072-0039	200 lbs.	Genoa Kneespace Storage Credenza - Mahogany	66"W x 20"D x 29"H	\$355.95	\$462.75	\$	-



14083-0117	290 lbs.	Genoa Exec. Desk - Mahogany - Double Pedestal	72"W x 36"D x 29"H	\$412.45	\$526.20	\$	-
14072-0042	250 lbs.	Presidential Kneespace Credenza - Mahogany	66"W x 24"D x 29"H	\$468.95	\$609.65	\$	-
14083-0125	250 lbs.	Presidential Executive Desk - Mahogany	72"W x 36"D x 29"H	\$581.95	\$756.55	\$	-
14143-0060	220 lbs.	Presidential File Cabinet - Mahogany	36"W x 24"D x 29"H	\$367.25	\$477.75	\$	-
05088-0365	70 lbs.	Vivid Café - Square Table Glass	42"Square x 30"H	\$355.95	\$462.75	\$	-
05088-0364	90 lbs.	Vivid Café - Rectangle Table Glass	60"W x 36"D x 30"H	\$412.45	\$536.20	\$	-
05088-0498		Brooklyn II Rect Dining Table	60"W x 36"D x 30"H	\$570.00	\$741.00	\$	-
05088-0499		Brooklyn II Round Dining Table	42" Round x 30"H	\$442.50	\$575.25	\$	-
05090-0001	90 lbs.	Aspen Dining Table	72"W x 30"D x 30"H	\$660.00	\$858.00	\$	-
<b>Metal File &amp; Storage Cabinets (Pg. 27)</b>							
14148-0001	35 lbs.	2 Drawer Vertical File - Letter Size Black	15"W x 25"D x 29"H	\$141.25	\$183.65	\$	-
14147-0001	35 lbs.	2 Drawer Vertical File - Legal Size Black	18"W x 25"D x 29"H	\$180.80	\$235.05	\$	-
14148-0002	45 lbs.	4 Drawer Vertical File - Letter Size Black	15"W x 25"D x 52"H	\$186.45	\$242.40	\$	-
14147-0002	45 lbs.	4 Drawer Vertical File - Legal Size Black	18"W x 25"D x 52"H	\$209.05	\$271.80	\$	-
14143-0006	100 lbs.	2 Drawer Lateral File - Black	36"W x 18"D x 27"H	\$186.45	\$242.40	\$	-
14143-0144	125 lbs.	2 Drawer Lateral File - Black	36"W x 20"D x 29"H	\$220.35	\$286.50	\$	-
14143-0008	170 lbs.	4 Drawer Lateral File - Black	36"W x 18"D x 54"H	\$237.30	\$308.50	\$	-
14034-0015	135 lbs.	Storage Cabinet - Black	36"W x 18"D x 72"H	\$237.30	\$308.50	\$	-
<b>Pedestals (Pg. 28)</b>							
12091-0023	50 lbs.	Display Pedestal 14" x 42" Black	14"Square x 42"H	\$282.50	\$367.25	\$	-
12091-0004	120 lbs.	Display Pedestal 24" x 42" Black	24"Square x 42"H	\$344.65	\$448.05	\$	-
12091-0002	55 lbs.	Display Pedestal 18" x 42" Black	18"Square x 42"H	\$316.40	\$411.35	\$	-
12091-0030	50 lbs.	Display Pedestal 14" x 42" White	14"Square x 42"H	\$282.50	\$367.25	\$	-
12091-0024	45 lbs.	Display Pedestal 14" x 36" Black	14"Square x 36"H	\$242.95	\$315.85	\$	-
12091-0034	75 lbs.	Display Pedestal 24" x 36" Black	24"Square x 36"H	\$344.65	\$448.05	\$	-
12091-0031	45 lbs.	Display Pedestal 14" x 36" White	14"Square x 36"H	\$242.95	\$315.85	\$	-
12091-0033	75 lbs.	Display Pedestal 24" x 36" White	24"Square x 36"H	\$344.65	\$448.05	\$	-
12091-0025	40 lbs.	Display Pedestal 14" x 30" Black	14"Square x 30"H	\$220.35	\$286.50	\$	-
12091-0003	80 lbs.	Display Pedestal 24" x 30" Black	24"Square x 30"H	\$327.70	\$426.05	\$	-
12091-0001	45 lbs.	Display Pedestal 18" x 30" Black	18"Square x 30"H	\$231.65	\$301.15	\$	-
12091-0032	40 lbs.	Display Pedestal 14" x 30" White	14"Square x 30"H	\$220.35	\$286.50	\$	-
14309-0001	125 lbs.	Locking Pedestal Black	24"Square x 42"H	\$429.40	\$558.25	\$	-
14179-0005	125 lbs.	Locking Pedestal White	24"Square x 42"H	\$429.40	\$558.25	\$	-
12091-0043	24 lbs.	London Pedestal	16"Square x 44"H	\$315.00	\$409.50	\$	-
<b>Miscellaneous Items (Pg. 29)</b>							
14189-0077	50 lbs.	Stanchion Chrome	41"H	\$62.15	\$80.80	\$	-
11526-0001	2 lbs.	Stanchion Rope - Red Velour	6' L	\$33.90	\$44.10	\$	-
14308-0009	8 lbs.	Literature Stand - Black	14.75"W x 12"D x 53.5"H	\$158.20	\$205.70	\$	-
14308-0010	8 lbs.	Literature Stand - Aluminum	14.75"W x 12"D x 53.5"H	\$158.20	\$205.70	\$	-
14308-0005	7 lbs.	Literature Rack - Black Metal	10.5"W x 9.5"D x 57"H	\$163.85	\$213.05	\$	-
01209-0003	50 lbs.	Compact Refrigerator White - 4.0 Cu Ft	19"W x 21"D x 33.5"H	\$293.80	\$381.95	\$	-
14523-0001	9.25 lbs.	iPad® Stand Black	14.25"W x 41.75"H	\$180.80	\$235.05	\$	-
14523-0002	9.25 lbs.	iPad® Stand Silver	14.25"W x 41.75"H	\$180.80	\$235.05	\$	-
<b>Lighting (Pg. 30)</b>							
09417-0001	4 lbs.	Brushed Steel Table Lamp - White	26"H	\$101.70	\$132.25	\$	-
09392-0001	8 lbs.	Brushed Steel Floor Lamp - White	66"H	\$146.90	\$191.00	\$	-
09417-0001	7 lbs.	Brushed Nickel Table Lamp - White	29"H	\$101.70	\$132.25	\$	-
09392-0001	12 lbs.	Brushed Nickel Floor Lamp - White	60"H	\$146.90	\$191.00	\$	-
09417-0001	7 lbs.	Rubbed Bronze Table Lamp - White	28"H	\$101.70	\$132.25	\$	-
09392-0001	11 lbs.	Rubbed Bronze Floor Lamp - White	60"H	\$146.90	\$191.00	\$	-
09417-0001	4 lbs.	Brushed Steel Table Lamp - Red	26"H	\$101.70	\$132.25	\$	-
09392-0001	8 lbs.	Brushed Steel Floor Lamp - Red	66"H	\$146.90	\$191.00	\$	-
09392-0001	7 lbs.	Neutrino Steel Floor Lamp - Steel	67"H	\$146.90	\$191.00	\$	-



**DO NOT MAIL ORDER FORM**  
**Email / Fax Form / Online ONLY**

Email [events@valleyexpodisplays.com](mailto:events@valleyexpodisplays.com)

Fax 815-873-1544

Online <https://valleyexpodisplays.boomerecommerce.com/>

<b>Total Product</b>	\$	-
<b>Late Fee %</b>	\$	-
<b>Sub Total</b>	\$	-
<b>Sales Tax %</b>	\$	-
<b>Total Amount Due</b>	\$	-

<b>Company Name</b>		<b>Credit Card Type</b>	
<b>Street Address</b>		<b>Credit Card #</b>	
<b>City</b>		<b>Card Holder</b>	
<b>State</b>		<b>Expiration Date</b>	<input type="text"/> <input type="text"/>
<b>Zip Code</b>		<b>Signature</b>	<b>Security Code</b>
<b>Name / Date of Show</b>			<input type="text"/>
<b>Booth Number</b>		<b>Date</b>	<input type="text"/>
<b>Contact Name</b>		<b>Email Address</b>	<input type="text"/>
<b>Contact Cell</b>		<b>Fax #</b>	<input type="text"/>
<b>Special Instructions:</b>	<input type="text"/>		



## EXHIBITOR RULES & REGULATIONS

Welcome to CenturyLink Center Omaha. Following is information you will need as an exhibitor at a convention, tradeshow, or consumer show in our facility. Please read this information thoroughly and abide by all rules and regulations as set forth by MECA.

### 1. IN-BOUND FREIGHT

CenturyLink Center Omaha will not accept any freight/shipments prior to the scheduled exhibitor move-in date unless pre-approved in writing by MECA. If any shipments arrive at MECA managed facilities prior to the show move-in day, it will be refused or transferred to MECA's preferred shipping company and the shipper will incur storage and delivery fees at their standard charge rates or the shipment may be refused.

Any freight arriving at MECA managed facilities on the show move-in day without a service contractor or drayage company specified, will be handled by MECA's preferred shipping company. The shipper will incur handling fees at their standard charge rates.

To avoid potential shipment refusal, prior arrangements are to be made with a service contractor or drayage company to handle freight/shipping requirements. Freight shipped to arrive prior to the day of exhibitor move-in should be forwarded according to the instructions in your exhibitor service kit provided by the official show decorator. If no official show decorator has been identified, freight should be forwarded to CenturyLink Center Omaha's preferred freight services provider, Target Logistic Services and Tradeshow Services, (402)457-7992.

Please call Target Logistic Services and Tradeshow Services at (402)457-7992 for available freight services and fees.

Contact information for the package(s) shall be clearly labeled on the exterior of the package(s). If this information is not clearly visible, the package(s) may be refused. All materials, equipment, or freight sent to arrive during scheduled move-in must be clearly labeled as follows:

CenturyLink Center Omaha  
*Name of event, date of event*  
*Exhibiting company name, booth number*  
*Phone Number*  
*c/o Name of Service Contractor or Drayage Company*  
 455 North 10<sup>th</sup> Street  
 Omaha, NE 68102

No COD deliveries will be accepted.

### 2. OUT-BOUND FREIGHT

Out-bound shipments should be arranged according to the instructions in your exhibitor service kit provided by the official show decorator. If no official show decorator has been identified, out-bound shipments can be arranged through CenturyLink Center Omaha's preferred freight services provider, Target Logistic Services and Tradeshow Services, (402)457-7992. All materials must be removed from CenturyLink Center Omaha at the conclusion of the event. Any materials remaining after scheduled move-out will be considered refuse. Costs incurred for removal of such refuse may be charged accordingly.



## EXHIBITOR RULES & REGULATIONS

### 3. EXHIBITOR MOVE-IN / MOVE-OUT

Exhibitor move-in and move-out is allowed only during designated exhibitor move-in and move-out hours. Exhibitors are not allowed to move in or out through the main entrances on the west, south, or north sides of the building. All exhibitors must unload and load on the east side of the building at the designated ramp/docks for the show. All exhibitors must check in with the traffic manager at the dock. To access the dock area, turn east off of 10<sup>th</sup> Street onto Meca Drive, which is on the north side of CenturyLink Center Omaha. Turn right on the east side of the building into the dock area.

**No vehicle parking is allowed at the dock.** Vehicles must be unloaded in a timely manner then moved to an assigned exhibitor parking lot. No overnight parking is allowed in any CenturyLink Center Omaha parking lots. Exhibitors will pay the prevailing parking rate per vehicle, per day, with no in and out privileges, except as may have been specifically arranged by the show promoter through MECA.

CenturyLink Center Omaha does not have available dollies, ladders, or other equipment needed for move-in and set-up. All such equipment must be brought with you or services must be acquired from the official show decorator. Standing on chairs or tables to hang display materials is prohibited.

### 4. STORAGE

There is no on-site storage or empty case storage available to exhibitors. All arrangements for storage must be made through the official show decorator. If no official show decorator has been identified, storage can be arranged through CenturyLink Center Omaha's preferred freight services provider, Target Logistic Services and Tradeshow Services, (402)457-7992.

### 5. FIRE AND SAFETY REGULATIONS

All exhibitors must comply with Omaha Fire Marshal rules and regulations.

**HAZARDOUS MATERIALS** – If your exhibit includes the use/display of hazardous materials (including, but not limited to, open flames, gasoline, welding materials, lasers, cooking grease, natural gas, combustible materials such as hay bales, all heat sources used for cooking and heater demonstrations, hazardous waste, medical waste, hazardous, toxic, and/or regulated substances), contact show management for reference to the CENTURYLINK CENTER OMAHA'S FACILITY RULES & REGULATIONS. Liquid propane is not allowed in the building. Any displays with a fire component require that the exhibitor supply a fire extinguisher in the booth.

**WEAPONS** – Weapons, of any type, are prohibited from being brought into CenturyLink Center Omaha. The sole exception to this policy is the display of such items within an exhibit – and in those occasions, MECA approval is required.



## EXHIBITOR RULES & REGULATIONS

### FIRE AND SAFETY REGULATIONS (cont.)

#### VEHICLES

- Vehicles are not permitted inside CenturyLink Center Omaha for loading/unloading without the prior authorization of MECA management.
- Vehicles which are part of a display will be allowed in CenturyLink Center Omaha after conforming with all fire/safety rules and regulations which include:
  1. Specific area for vehicles is identified on the floor plan.
  2. The vehicle engine will not be operated when the building is occupied.
  3. A maximum of 5 gallons of fuel per vehicle when entering the building.
  4. The fuel fill cap is secured with a lock or securely taped with a material that is non-petroleum soluble.
  5. The battery cables are disconnected from the battery and the battery terminal will be securely covered.
  6. The vehicle will be securely locked when unattended.
  7. An approved fire extinguisher will be located in the immediate vicinity.
  8. The Fire Marshal's office may inspect the vehicles prior to the building being opened to the general public.

### 6. IN BOOTH FOOD DISTRIBUTION

Any distribution of food as part of an exhibit must be pre-approved by Levy Restaurants, CenturyLink Center Omaha's exclusive food and beverage service provider. Please refer to the documents listed below, which must be completed at least two (2) weeks prior to the show date. These documents are included in the exhibitor service kit or are available on-line at [www.qwestcenteromaha.com](http://www.qwestcenteromaha.com). For additional information, please contact Levy Restaurants, (402)341-1500.

"Authorization Request - Sample Food and/or Beverage Distribution"  
 "Exhibitor Catering – Order Form"

### 7. GARDENING / LANDSCAPING EXHIBITS

The following apply to gardening and landscaping exhibits:

- Plastic must be used on the exhibit hall floor under dirt, rocks, mulch, ponds, etc.
- Considerable care must be taken when using dump trucks, skid loaders, etc., to unload and load dirt, rocks, mulch, etc. Any damage incurred will be the responsibility of the exhibitor.
- At the close of the show, all dirt, rocks, mulch, etc., must be removed completely and the exhibit hall floor must be swept clean.
- Ponds and water displays must be filled and emptied only by CenturyLink Center Omaha staff and a charge will be incurred based on the fill/drain tank rates on the CenturyLink Center Omaha Exhibitor Utilities/Technical Services Order Form.
- Any damage incurred due to water leakage will be the responsibility of the exhibitor.



## EXHIBITOR RULES & REGULATIONS

### 8. AUDIO VISUAL

J&S Audio Visual, Inc. is the preferred in-house audiovisual services provider and rigger at CenturyLink Center Omaha. Please refer to the "Audio Visual Exhibitor Order Form" and the "Audio Visual Rules & Regulations" for available equipment. These forms are included in the exhibitor service kit or are available on-line at [www.qwestcenteromaha.com](http://www.qwestcenteromaha.com).

### 9. UTILITY AND TECHNICAL SERVICES

Electrical, air, gas water, telephone and internet services are provided by MECA. Please refer to the "CenturyLink Center Omaha Exhibitor Utilities/Technical Services Order Form" and the "Exhibitor Utility/Technical Services Rules & Regulations" for available services. These forms are included in the exhibitor service kit or are available on-line at [www.qwestcenteromaha.com](http://www.qwestcenteromaha.com). Advance rates require that order forms and full payment must be postmarked or received a minimum of seven (7) calendar days PRIOR to the first move-in day of the show. Floor rates will apply after the deadline.

### 10. GRATUITIES

CenturyLink Center Omaha prohibits its employees from accepting gifts, gratuities, or other favors from parties doing business with CenturyLink Center Omaha.

### 11. NO SMOKING POLICY

CenturyLink Center Omaha is a smoke-free facility.

### 12. SPECIAL DECORATIONS, SIGNS AND THEMED MATERIALS

- Under no circumstances are helium balloons or adhesive-backed decals to be given away or permitted to be used in CenturyLink Center Omaha.
- Tape and adhesive-backed materials are not allowed on CenturyLink Center Omaha carpeted surfaces.
- Use of tape on any wall surface, glass, or equipment is prohibited.
- Cut trees are not permitted, unless they have a root ball at the base of the tree and are specifically approved by MECA.
- Hay bales must be sprayed with fire retardant and inspected by the Fire Marshal prior to the building opening to the public.
- Use of glitter, confetti or streamers must be approved in advance by MECA. If approved, Licensee will be charged for any extra cleaning required due to use of such decorations.
- Cotton candy machine use is prohibited in the Convention Center. Snow cone makers and the use of dry ice shall require a protective floor covering in the working area of these machines and/or products.
- Game themed activities may require precautionary measures to protect the facility and its patrons.





## EXHIBITOR UTILITIES & TECHNICAL SERVICES

ORDER ONLINE AT [WWW.CENTURYLINKCENTEROMAHA.COM](http://WWW.CENTURYLINKCENTEROMAHA.COM)

### Navigating our site....

Once you are on our website, select “**Convention Center**” from the menu bar at the top of the page. This will take you to the convention center home page. While there, you will see a tab on the left side of the screen for “**EXHIBITORS**”. Click on that tab to reveal the list of exhibitor information. From that list, select “**Online Ordering**” and begin the ordering process which starts by selecting your event from the event list.

All exhibitors are responsible for reading and complying with the **Exhibitor Rules & Regulations** and the **Exhibitor Technical Rules & Regulations**. These documents cover topics such as shipping/receiving (*the facility does not accept exhibitor shipments*), fire & safety regulations, and policies regarding special decorations....*just to name a few*. They are located on our website within the list of exhibitor information when you select “**Downloadable Order Forms**.”

**Order Deadline:** *All orders must be received or post marked seven (7) calendar days prior to the designated exhibitor move-in date to qualify for the advance rates otherwise standard rates will apply.*

# ORDER ONLINE AT [www.centurylinkcenteromaha.com](http://www.centurylinkcenteromaha.com)



EXHIBITOR  
UTILITIES / TECHNICAL  
SERVICES ORDER FORM  
UP TO A 4 DAY EVENT



## PRICING DEADLINE

ORDER MUST BE RECEIVED BY FAX OR POSTMARKED 7 CALENDAR DAYS BEFORE MOVE-IN DATE FOR ADVANCE (Adv.) RATE OTHERWISE STANDARD (Std.) RATE APPLIES

<b>Information Technology</b>				
<b>WIRED INTERNET</b>	Qty.	Adv. Rate	Std. Rate	Total
Shared Wired Broadband Internet Up to 5 MB (1st PC)		\$ 140.00	\$ 165.00	
-Additional PCs Up to 5 MB		87.00	102.50	
Dedicated Wired VLAN Up to 5 MB		320.00	375.00	
-Additional PCs on Dedicated VLAN Up to 5 MB		185.00	215.00	
<b>WIRELESS INTERNET</b>	Qty.	Adv. Rate	Std. Rate	Total
Wireless Broadband Internet Up to 5 MB (1st device)		\$ 105.00	\$ 122.50	
-Additional Wireless devices		26.00	31.00	
<b>VOICE</b>	Qty.	Adv. Rate	Std. Rate	Total
Analog Phone Line / Credit Card Line / Fax line		\$ 140.00	\$ 165.00	
ISDN		236.00	295.00	
Long Distance Deposit		28.00	35.00	
<b>EQUIPMENT RENTAL</b>	Qty.	Adv. Rate	Std. Rate	Total
PC / Laptop Rental - per day		\$ 124.00	\$ 155.00	
19" LCD Monitor - per day		135.00	165.00	
<b>Total Information Technology: \$</b>				
<i>Other Services Available Upon Request</i>				
Internet includes web browsing and internet e-mail. See Rules & Regs for details. Wireless networks are forbidden without express written permission of MECA. Long distance available with non refundable deposit				

**Banner & Sign Hanging**  
Contact MECA for quote (402) 599-6703 or exhibitorservices@omahameca.com

**Shipping/Receiving**  
**The facility does not accept shipments.**  
Contact show decorator. If no show decorator is designated, contact T.L.K. for freight services at (402)-457-7992.

**Exhibitor Information**  
**ALL INFORMATION IS REQUIRED**

Event Name \_\_\_\_\_

Company Name \_\_\_\_\_ Booth # \_\_\_\_\_

Address \_\_\_\_\_

City \_\_\_\_\_ State \_\_\_\_\_ Zip \_\_\_\_\_

Phone # \_\_\_\_\_ Fax # \_\_\_\_\_

E-mail: \_\_\_\_\_

On Site Contact: \_\_\_\_\_

By signing below, I acknowledge that I have read, understand, and agree to the terms stated in the Utility/Technical Services Rules & Regulations as well as the Exhibitor Rules & Regulations. All Rules & Regulations documents are available at [www.centurylinkcenteromaha.com](http://www.centurylinkcenteromaha.com).

Signature \_\_\_\_\_ Date \_\_\_\_\_

**MECA Contact Information:**

455 N 10th Street, Omaha, NE 68102  
Phone: (402) 599-6703 Fax: (402) 599-6725  
Website: [www.centurylinkcenteromaha.com](http://www.centurylinkcenteromaha.com)  
E-mail: [exhibitorservices@omahameca.com](mailto:exhibitorservices@omahameca.com)

25% additional charge per day over 4 days. Please use the 5 Day Event order form.

<b>Mechanical</b>				
	Qty.	Adv. Rate	Std. Rate	Total
Compressed Air		\$ 160.00	\$ 200.00	
-Additional Air Lines		45.50	57.00	
Natural Gas Line w/1/2" connection		160.00	200.00	
-Additional Gas Lines		45.50	57.00	
Sink Connection/drain (continuous)		252.00	315.00	
Fill/drain tank/spa 500g max (1 fill / 1 drain)		116.00	145.00	
Fill/drain tank/spa 500-1,000g max (1 fill / 1 drain)		164.00	205.00	
Fill/drain tank/spa 1,000g +		call for pricing		
<b>Total Mechanical: \$</b>				
<i>Compressed Air:</i> Exhibitor must supply own drier or regulator for critical applications. 1/2" Universal Quick Disconnect w/ 3/8" line required. <i>Natural Gas:</i> Low pressure gas. Available in limited locations (on interior columns). Exhibitors using natural gas must supply a fire extinguisher in their booth.				

<b>Electrical</b>				
	Qty.	Adv. Rate	Std. Rate	Total
120v, 20 Amp (standard outlet)		\$ 77.00	\$ 110.00	
208v, 30 Amp, Single Phase		121.00	173.00	
208v, 50 Amp, Single Phase		150.50	215.00	
208v, 20 Amp, 3 Phase		138.25	197.50	
208v, 30 Amp, 3 Phase		207.50	296.50	
208v, 40 Amp, 3 Phase		276.50	395.00	
Extension Cords & Power Strips		call for pricing		
24 Hour Power		call for pricing		
<b>Total Electrical: \$</b>				
<i>Other Services Available Upon Request</i>				
<i>Custom Services:</i> Hard wire connection including lighting, more than 3 outlets ordered, antenna or satellite downlink connections, booth to booth cable runs, overhead power and changes to orders are at the discretion of the Electrician. 480v available in limited locations, please call for specifics.				

**Services Grand Total: \$**

**Payment Information**  
**FULL PAYMENT FOR SERVICES ORDERED MUST ACCOMPANY THIS FORM**  
**NO PERSONAL CHECKS ACCEPTED**

\_\_\_\_\_ Company Check (Payable to MECA) **{U.S. Funds Only}**

**CREDIT CARD INFORMATION:**  
\_\_\_\_\_ Visa \_\_\_\_\_ MasterCard \_\_\_\_\_ American Express \_\_\_\_\_ Discover

Company/Cardholder's Name \_\_\_\_\_

Cardholder's Billing Address \_\_\_\_\_

City \_\_\_\_\_ State \_\_\_\_\_ Zip \_\_\_\_\_ Phone # \_\_\_\_\_

Are You The Cardholder ( ) Yes ( ) No Is This a Corporate Card ( ) Yes ( ) No

This Card will be used to pay for charges by the following authorized users: (please print)

1) \_\_\_\_\_ 2) \_\_\_\_\_

Credit Card # \_\_\_\_\_ Exp. \_\_\_\_\_

Security Code (required) \_\_\_\_\_

By signing below, I acknowledge and agree that if the Exhibitor Services Order Form is received by fax or post marked after the 7-day advance order deadline, I will no longer be eligible for the Advance rates and my card will be charged the Standard rates.

Signature \_\_\_\_\_ Date \_\_\_\_\_

Electrical orders provide for a connection to our power source ran to the booth space, no additional labor. Facility staff is not authorized to hard wire any machines/equipment. Please be sure your equipment is compatible with our connectors.

Exhibitors ordering a 30 amp connection will have the following connector ran to their booth:

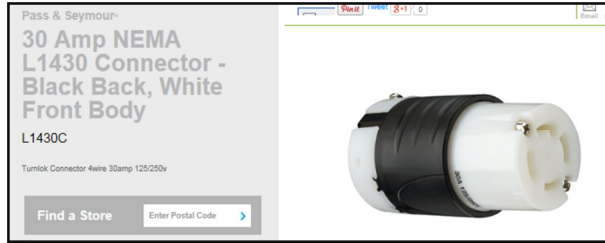

TECHNICAL INFORMATION
Amps: 30A
NEMA Configuration Number: L1430
Volts: 125/250V
Volts A C: 125/250

DIMENSIONS
Diameter (U S): 2.20"
Length (U S): 3.33"

Below is an example of a compatible plug that should be on the exhibitor's equipment:

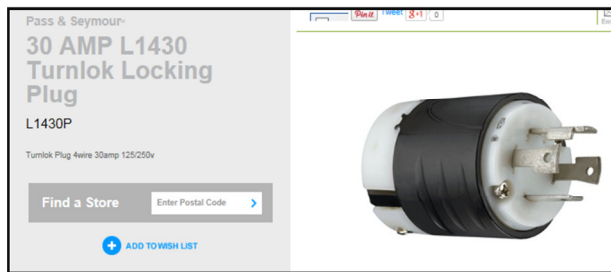

TECHNICAL INFORMATION
Amps: 30A
NEMA Configuration Number: L1430
Volts: 250V

DIMENSIONS
Diameter (U S): 2.20"
Length (U S): 3.75"

Exhibitors ordering a 50 amp connection will have the following connector ran to their booth:



Below is an example of a compatible plug that should be on the exhibitor's equipment:

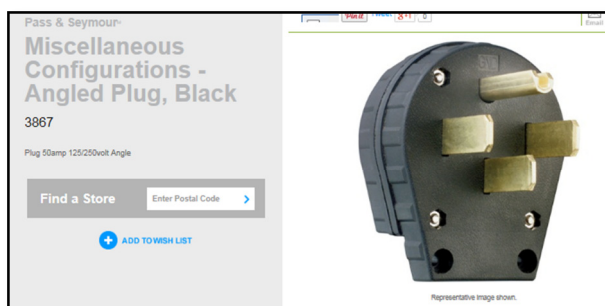

TECHNICAL INFORMATION
Amps: 50 Amp
Volts: 125/250V
Volts A C: 125/250
Grade Type: Specification

DIMENSIONS
Depth (U S): 1.36"
Height (U S): 3.43"
Width (U S): 2.77"



J&S Audio Visual, Inc. Office at CenturyLink Center Omaha Effective 07-01-17  
 455 North 10th Street \* Omaha, NE 68102 \* Phone: (402) 599-6492 \* E-Mail charliew@jsav.com \* www.jsav.com  
 Advance Order Deadline Is Two Weeks (14 Days) Before Show Date

Equipment	Quantity	Advance Rate	Floor Rate	Total
<b>AUDIO</b>				
Audio CD Player		\$40.00	\$45.00	
Computer Audio Interface Unit		\$20.00	\$25.00	
MP3 Digital Audio Recorder		\$40.00	\$45.00	
Wireless Microphone Combo Kits		\$125.00	\$140.00	
SM58 Vocal Professional Microphone		\$40.00	\$45.00	
Wireless Headset Microphone		\$175.00	\$195.00	
4-Channel Audio Mixer		\$40.00	\$45.00	
6-Channel Audio Mixer		\$50.00	\$55.00	
16-Channel Audio Mixer		\$100.00	\$110.00	
Full Range Speaker (EV)		\$75.00	\$85.00	
Polycom Audio Teleconference		\$50.00	\$55.00	
Direct Box		\$20.00	\$25.00	
<b>Labor</b>				
AV Technician (per hour-4 hr min)		\$45.00	\$67.50	
AV Engineer (per hour-4 hr min)		\$55.00	\$82.50	
<b>MISCELLANEOUS</b>				
Display Easel		\$10.00	\$15.00	
Flipchart Easel w/ Pad & Markers		\$40.00	\$45.00	
PC Wireless Mouse		\$15.00	\$20.00	
AV Cart w/Skirt		\$15.00	\$20.00	
<i>Specify Size: 34" / 42" / 54"</i>				
Safelock Stand w/Skirt		\$15.00	\$20.00	
HDMI Distribution Amp 1x4		\$55.00	\$60.00	
HDMI Cable 25'		\$15.00	\$20.00	
VGA Cable 25'		\$15.00	\$20.00	
VGA Distribution Amp 1x4		\$25.00	\$30.00	

<b>EXHIBITOR INFORMATION</b>	
<b>ALL INFORMATION IS REQUIRED</b>	
Event Name _____	
Company Name _____	Booth # _____
Address _____	
City _____	State _____ Zip _____
Phone # _____	Fax # _____
E-Mail _____	
On Site Contact _____	
If Delivery Date Differs from Actual Show Dates Please Indicate	
Delivery Date _____	Time _____
By signing below, I acknowledge that I have read, understand and agree to the Audio Visual Rules and Regulations.	
Signature _____	Date _____

Equipment	Quantity	Advance Rate	Floor Rate	Total
<b>VIDEO</b>				
Tripod Screen		\$40.00	\$45.00	
<i>Specify Size: 5' / 6' / 7' / 8'</i>				
BluRay/DVD Player		\$75.00	\$85.00	
24" LCD HDTV		\$100.00	\$110.00	
42" LCD HDTV		\$250.00	\$275.00	
55" LED/LCD HDTV		\$350.00	\$385.00	
70" LED/LCD HDTV		\$550.00	\$605.00	
<i>Specify TV Stand: Floor / Tabletop / Truss Mount / Wall Mount</i>				
Floor Stand or Wall Mount		\$75.00	\$85.00	
Truss Tower and Truss Mount		\$150.00	\$165.00	
LCD Projector (4500 Lumens)		\$350.00	\$385.00	
<b>Please Contact Your J&amp;S Representative For:</b> More Complex Audio or Video Systems, Lighting Equipment Items Not Listed or Special Requests, Rigging				
<b>CALCULATING YOUR ORDER</b>				
Instructions:				
1. Multiply Quantity of Items by		\$ _____		
Applicable Daily Rental				
2. Multiply Total of Line 1 by # of Show Days		\$ _____		
3. Delivery, 30 Minute Setup, and Pickup N/C				
4. Calculate Tax 7.00% Nebraska Sales Tax		\$ _____		
5. Additional Labor (Please Call Us)		\$ _____		
<b>TOTAL \$</b>				
<b>PAYMENT INFORMATION</b>				
____ Company Check (Payable to MECA) <b>{U.S. Funds Only}</b>				
____ Visa ____ MasterCard ____ American Express ____ Discover				
<b>NO PERSONAL CHECKS ACCEPTED</b>				
<b>CREDIT CARD INFORMATION:</b>				
Company/Cardholder's Name _____				
Cardholder's Billing Address _____				
City _____ State _____ Zip _____ Phone # _____				
Are You The Cardholder ( ) Yes ( ) No				
Is This a Corporate Card ( ) Yes ( ) No				
This Card will be used to pay for charges by the following authorized users: Please print.				
(1) _____ (2) _____				
Credit Card # _____ Exp. _____				
CVV _____				
Signature _____ Date _____				

Your J&S Representative at CenturyLink Center Omaha is Charlie Wagner